

DIAGNOSTIC INSTRUMENTS AND SCALPEL HANDLES



**WARTENBERG
 NEUROLOGICAL PIN WHEEL**
 17-150-18
 7" (178mm)



TAYLOR PERCUSSION HAMMER
 17-190-18 17-190-20
 7" (178mm) 8" (203mm)
 Small large

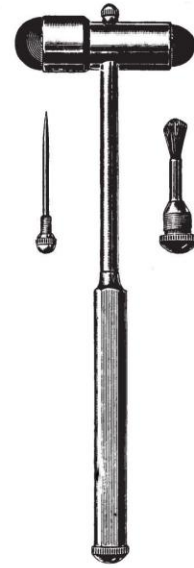

BUCK NEUROLOGICAL HAMMER
 17-156-18 7 3/4" (195mm) chrome
 with brush and needle



SCALPEL HANDLE # 3
 10-130-04
 for blades 10 through 15



SCALPEL HANDLE # 3
 10-130-05
 for blades 10 through 15



SCALPEL HANDLE # 3L
 10-133-31
 extra long
 8 1/2" (216mm)
 for blades 10 through 15

SCALPEL HANDLES



MINI SCALPEL HANDLE # 3K
01-012-10
10cm, 4"



SCALPEL HANDLE #4
10-100-04
for blades 20 through 25



SCALPEL HANDLE # 7
10-137-07
for blades 10 through 15



SCALPEL HANDLE # 9
10-137-09
for blades 10 through 15 extra fine

SUPER-CUT SCISSORS

Primax Super-Cut Scissors

Super-Cut Scissors represent a truly remarkable advance in scissors technology. Using the finest surgical steels, the latest heat treating methods and master craftsmanship, the upper blade of the scissors is ground to a razor-sharp edge. This process creates scissors with an unprecedented smooth and effective cutting action.

Some of the benefits of Primax Super-Cut Scissors:

- Cut through soft and fibrous tissue without effort.
- Superb control permits precision in dissection.
- Less hand fatigue for the surgeon and less trauma for the patient.
- Retain sharpness longer than ordinary scissors.
- Ring handles are black-coated for easy identification.
- Fully autoclavable.
- Backed by Primax's lifetime guarantee.
- Not recommended for fiberglass or plaster splints.

Not recommended for fiberglass or plaster splints. Surgeons who use our Super-Cut Scissors are convinced of their superior performance and won't do without them on their surgical trays.

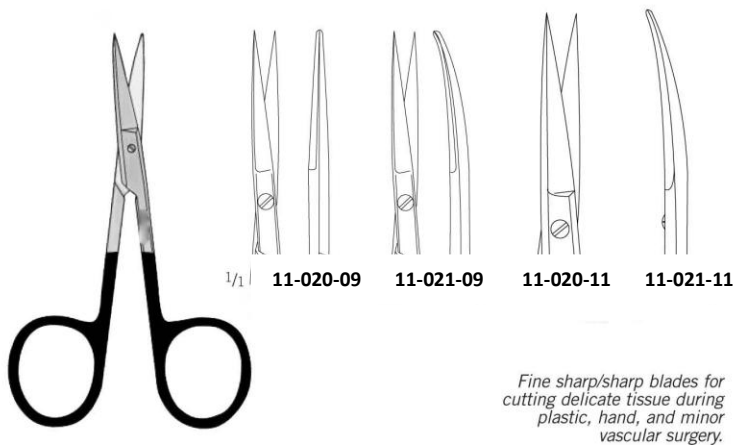
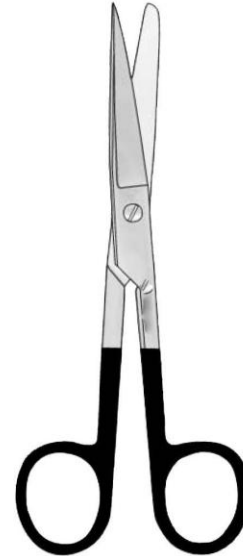

SUPER-CUT IRIS SCISSORS sharp points

Straight
 11-020-09 3½" (89mm) delicate
 11-020-11 4 ½" (114mm)
curved
 11-021-09 3 ½"(89mm) delicate

Fine sharp/sharp blades for cutting delicate tissue during plastic, hand, and minor vascular surgery.

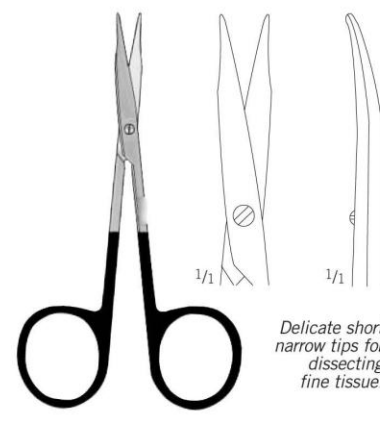

SUPER-CUT STEVENS SCISSORS blunt points

straight
 11-028-11 4 ½"

curved
 11-029-11 4 ½"(114mm)
 11-029-14 5¼"(133mm)

Delicate short narrow tips for dissecting fine tissue.

SUPER-CUT SCISSORS



Flat, blunt scissors for dissecting soft tissue.

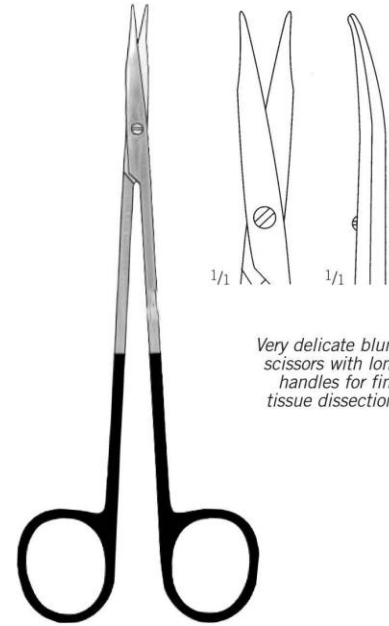

Very delicate blunt scissors with long handles for fine tissue dissection.

SUPER-CUT BABY METZENBAUM SCISSORS blunt points

11-014-11	11-015-11
4 ½"(114mm)	4 ½"(114mm)
<i>straight</i>	<i>curved</i>

SUPER-CUT JAMISON SCISSORS

11-058-16 6 ¼" (159mm)
 curved blunt points, very delicate

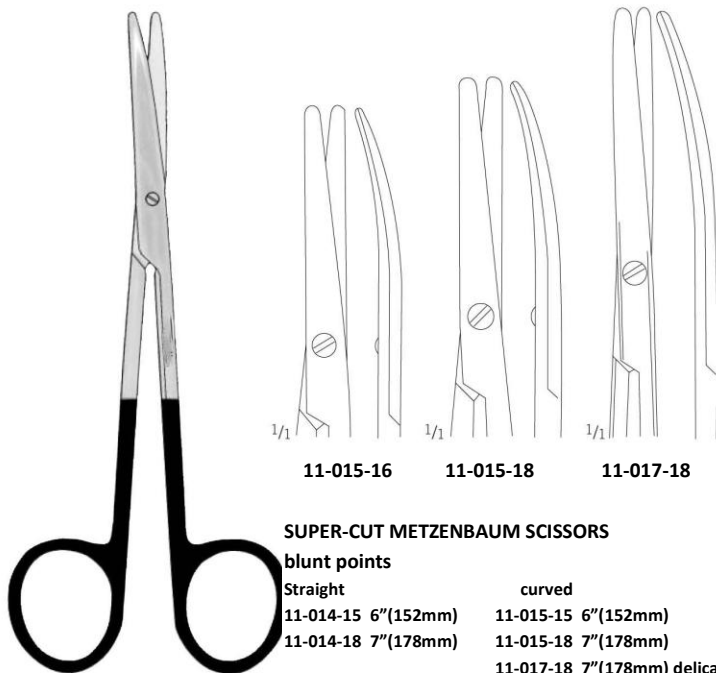

SUPER-CUT METZENBAUM SCISSORS

blunt points	
Straight	curved
11-014-15 6"(152mm)	11-015-15 6"(152mm)
11-014-18 7"(178mm)	11-015-18 7"(178mm)
	11-017-18 7"(178mm) delicate
	11-015-18 8"(203mm)
	11-015-23 9"(229mm)
	11-015-28 11"(279mm)

SUPER-CUT OPERATING SCISSORS

11-006-14	11-007-14
5 ½"(140mm)	5 ½"(140mm)
straight sharp/blunt	curved sharp/blunt

SUPER-CUT SCISSORS

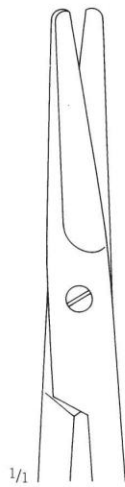
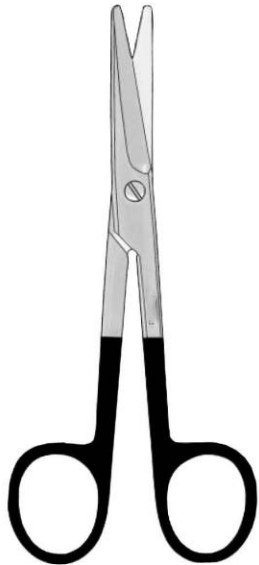

11-002-14

SUPER-CUT MAYO SCISSORS

beveled blades, blunt points

straight

11-002-14 5 ½" (140mm)

11-002-17 6 ¾" (171mm)

11-002-23 9" (229mm)

curved

11-003-14 5 ½" (140mm)

11-003-17 6 ¾" (171mm)

11-003-23 9" (229mm)

11-003-28 11" (279mm)

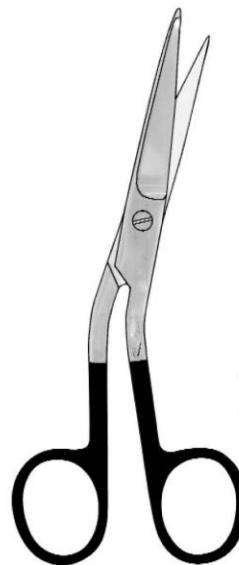

The delicate offset shanks provide increased leverage. The fine knob slides easily under finger and toe bandages. Excellent for small bandages!

SUPER-CUT HI-LEVEL BANDAGE SCISSORS

11-060-14

5 ½" (140mm)

shanks angled on side

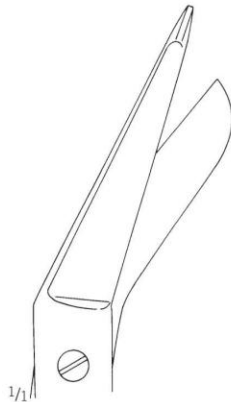

11-062-14

Cuts bandages and multiple layers of dressings with ease. Razor sharp blades reduce hand fatigue.

SUPER-CUT LISTER BANDAGE SCISSORS

11-062-14

11-062-18

5 ½" (140mm)

7 ¼" (184mm)

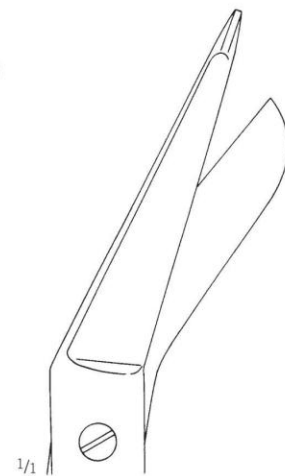
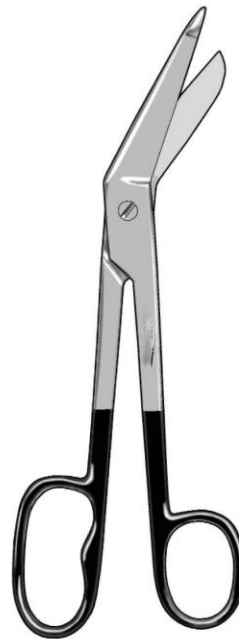

All the benefits of our Super-Cut Lister scissors plus an oversized finger ring, which helps relieve pressure on the third metacarpal.

SUPER-CUT LISTER BANDAGE SCISSORS

WITH LARGE FINGER RING

11-062-20

8" (203mm)

TUNGSTEN CARBIDE SCISSORS

Tungsten carbide (TC) is one of the hardest alloys made today. Our TC scissors have tungsten carbide firmly bonded to both cutting edges. We guarantee that they will stay sharp for at least three years. The finger rings are gold plated for easy identification.

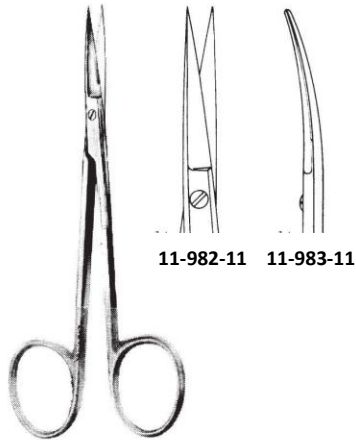

TC IRIS SCISSORS
 11-982-11 11-983-11
 4 ½" (114mm) 4 ½" (114mm)
 straight curved
 sharp points sharp points

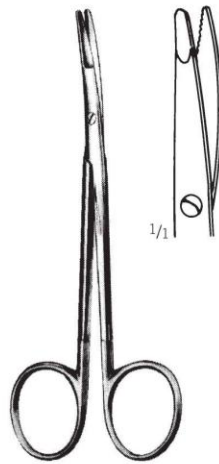

BLEPHAROPLASTY SCISSORS
 11-990-11
 4 ½" (114mm) curved flat tips, one
 serrated and one carbide blade

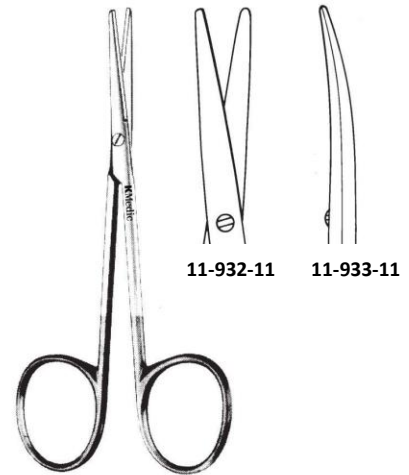

TC STRABISMUS SCISSORS
 11-932-11 11-933-11
 4 ½" (114mm) 4 ½" (114mm)
 straight curved
 blunt points blunt points

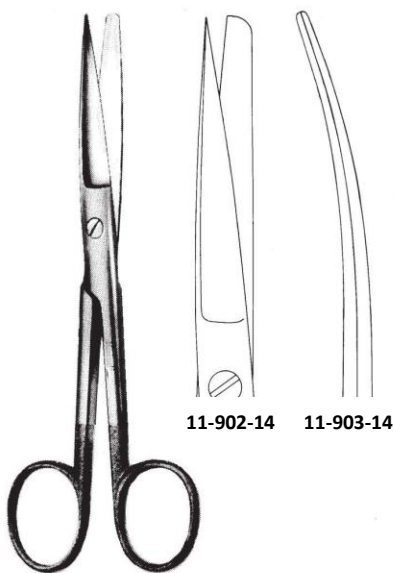

TC OPERATING SCISSORS
 11-902-14 11-903-14
 5 ½" (140mm) 5 ½" (140mm)
 Straight curved
 sharp/blunt sharp/blunt

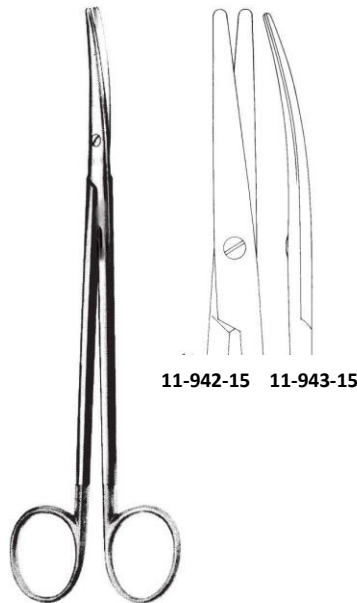

TC METZENBAUM SCISSORS blunt points
 straight curved
 11-942-15 6" 11-943-15 6" (152mm)
 11-942-18 7" 11-943-18 7" (178mm)
 11-942-23 9" 11-943-23 9" (229mm)

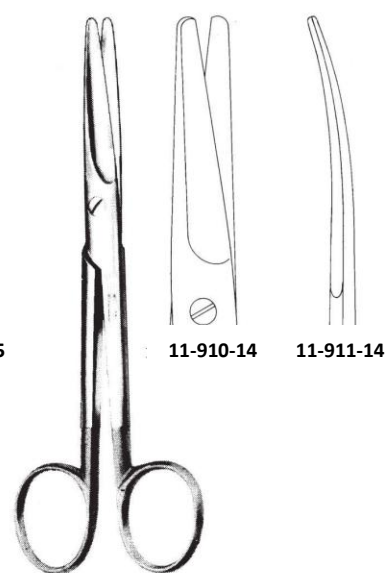

TC MAYO SCISSORS beveled blades
 straight curved
 11-910-14 5 ½" 11-911-14 5 ½" (140mm)
 11-910-16 6 ¼" 11-911-16 6 ¼" (171mm)
 11-910-23 9" 11-911-23 9" (229mm)

OPERATING SCISSORS

Most scissors can be serrated upon request.

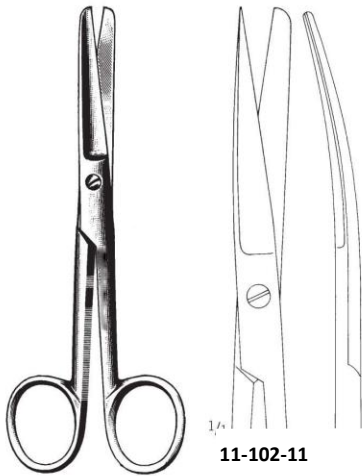

11-102-11

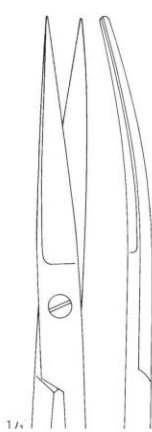

11-104-11

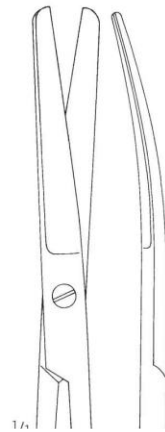

11-100-11

OPERATING SCISSORS straight

- 11-100-11 4 ½" (114mm) blunt/blunt
- 11-102-11 4 ½" (114mm) sharp/blunt
- 11-104-11 4 ½" (114mm) sharp/sharp
- 11-100-13 5 (127mm) blunt/blunt
- 11-102-13 5 (127mm) sharp/blunt
- 11-104-13 5 (127mm) sharp/sharp
- 11-100-14 5 ½" (140mm) blunt/blunt
- 11-102-14 5 ½" (140mm) sharp/blunt
- 11-104-14 5 ½" (140mm) sharp/sharp
- 11-100-16 6 ½" (165mm) blunt/blunt
- 11-102-16 6 ½" (165mm) sharp/blunt
- 11-104-16 6 ½" (165mm) sharp/sharp

OPERATING SCISSORS curved

- 11-101-11 4 ½" (114mm) blunt/blunt
- 11-103-11 4 ½" (114mm) sharp/blunt
- 11-105-11 4 ½" (114mm) sharp/sharp
- 11-101-13 5 (127mm) blunt/blunt
- 11-103-13 5 (127mm) sharp/blunt
- 11-105-13 5 (127mm) sharp/sharp
- 11-101-14 5 ½" (140mm) blunt/blunt
- 11-103-14 5 ½" (140mm) sharp/blunt
- 11-105-14 5 ½" (140mm) sharp/sharp
- 11-101-16 6 ½" (165mm) blunt/blunt
- 11-103-16 6 ½" (165mm) sharp/blunt
- 11-105-16 6 ½" (165mm) sharp/sharp

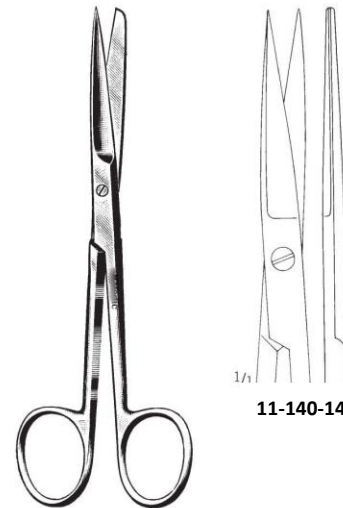

11-140-14

DEAVER SCISSORS 5 ½" (140mm)

- | | |
|-----------------------|-----------------------|
| <i>Straight</i> | <i>curved</i> |
| 11-140-14 sharp/blunt | 11-141-14 sharp/blunt |
| 11-144-14 sharp/sharp | 11-145-14 sharp/sharp |

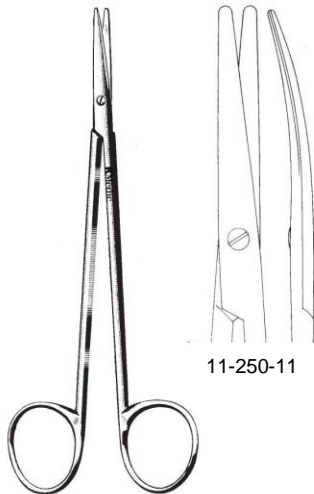

11-250-11

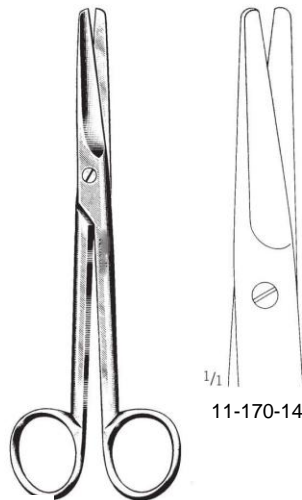

11-170-14

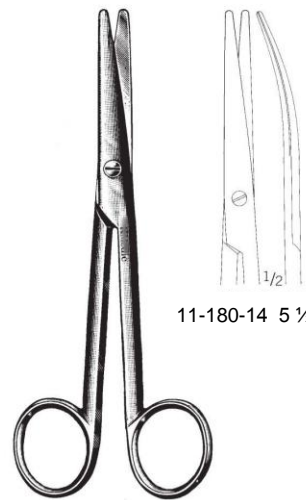

11-180-14 5 ½"

METZENBAUM SCISSORS blunt points

- | | |
|-----------------|-----------------------------|
| <i>Straight</i> | <i>curved</i> |
| 11-250-11 4 ½" | 11-251-11 4 ½" (114mm) |
| 11-264-15 6" | 11-327-14 5 ¾" (146mm) del. |
| 11-250-18 7" | 11-265-15 6" (152mm) |
| | 11-251-18 7" (178mm) |
| | 11-331-18 7" (178mm) del. |
| 11-250-20 8" | 11-251-20 8" (203mm) |
| 11-250-23 9" | 11-251-23 9" (229mm) |
| 11-250-28 11" | 11-251-28 11" (279mm) |

MAYO SCISSORS beveled blades

- | | |
|-----------------|------------------------|
| <i>straight</i> | <i>curved</i> |
| 11-170-14 5 ½" | 11-171-14 5 ½" (140mm) |
| 11-170-17 6 ¼" | 11-171-17 6 ¼" (171mm) |
| 11-170-17 9" | 11-171-17 9" (229mm) |
| <i>serrated</i> | <i>serrated</i> |
| 11-176-17 6 ¼" | 11-177-17 6 ¼" (171mm) |

MAYO-STILLE SCISSORS rounded blades

- | | |
|-----------------|------------------------|
| <i>Straight</i> | <i>curved</i> |
| 11-180-14 5 ½" | 11-181-14 5 ½" (140mm) |
| 11-181-17 6 ¾" | 11-181-17 6 ¾" (171mm) |

OPERATING SCISSORS

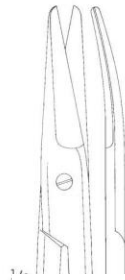
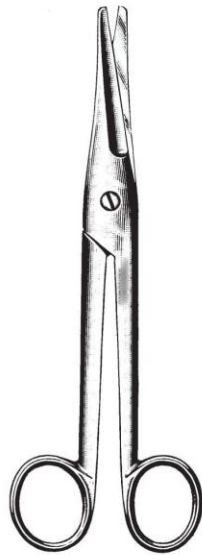

11-190-17

MAYO-NOBLE SCISSORS beveled blades
 11-190-17 11-190-17
 6 1/2" (165mm) 6 1/2" (165mm)
 straight curved

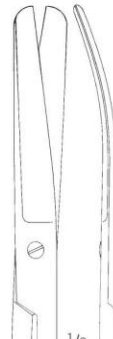
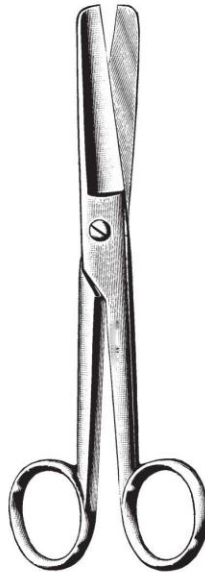

11-230-17

DOYEN ABDOMINAL SCISSORS
 11-230-17 11-231-17
 7" (178mm) 7" (178mm)
 straight curved

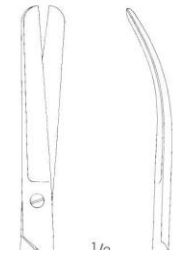
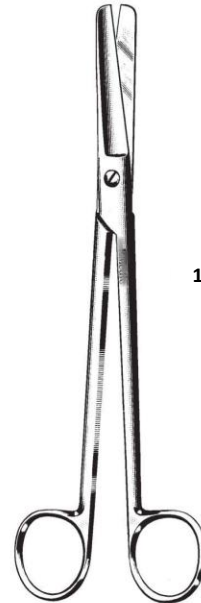

11-200-20 11-203-20

SIMS SCISSORS 8(203mm)
 straight curved
 11-200-20 sharp/sharp 11-203-20 sharp/sharp
 11-201-20 sharp/blunt 11-204-20 sharp/blunt
 11-202-20 blunt/blunt 11-205-20 blunt/blunt

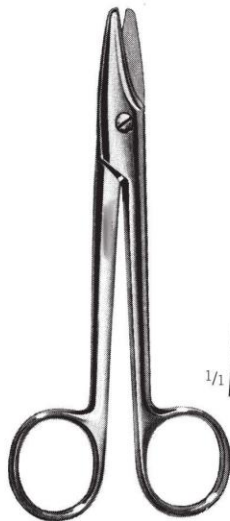

1/1

SISTRUNK SCISSORS heavy pattern
 00-100-94 00-101-94
 5 1/2" (140mm) 5 1/2" (140mm)
 straight curved

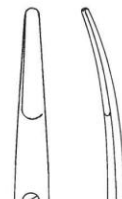
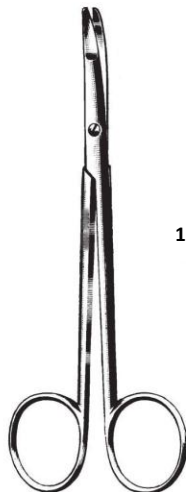

11-991-12 11-991-17

RAGNELL SCISSORS
 11-991-12 11-991-17
 5" (127mm) 7" (178mm)
 curved curved
 flat blunt tips flat blunt tips

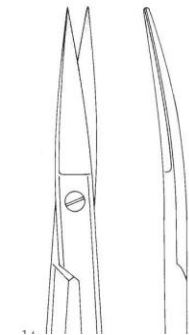

11-226-16 11-227-16

KELLY FISTULA SCISSORS 6 1/4"(159mm)
 smooth sharp/sharp
 11-226-16 straight
 11-227-16 curved
 11-228-16 angular

OPERATING SCISSORS



11-630-11 11-635-11

IRIS SCISSORS sharp points

- | | |
|------------------|--------------------------|
| straight | curved |
| 11-630-09 3 1/2" | 11-631-09 3 1/2" (89mm) |
| 11-630-11 4 1/2" | 11-631-11 4 1/2" (114mm) |
| 11-632-10 4 1/4" | 11-633-10 4 1/4" (105mm) |
| delicate | delicate |
| | angled on side |
| | 11-635-11 4 1/2" (114mm) |

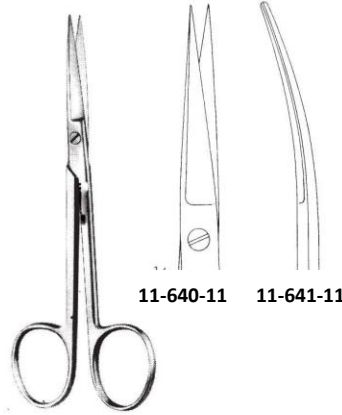

11-640-11 11-641-11

PLASTIC SURGERY SCISSORS 4 3/4"(121mm)

- | | |
|-----------------------|-----------------------|
| straight | curved |
| 11-640-11 sharp/sharp | 11-641-11 sharp/sharp |
| 11-642-11 sharp/blunt | 11-643-11 sharp/blunt |
| 11-644-11 blunt/blunt | 11-645-11 blunt/blunt |
| | angled on side |
| | 11-646-11 sharp/sharp |

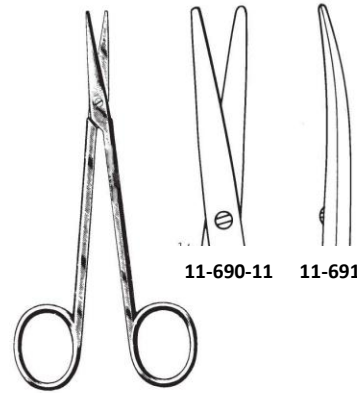

11-690-11 11-691-11

STRABISMUS SCISSORS

- | | |
|--------------|--------------|
| 11-690-11 | 11-691-11 |
| 4" (102mm) | 4" (102mm) |
| straight | curved |
| blunt points | blunt points |

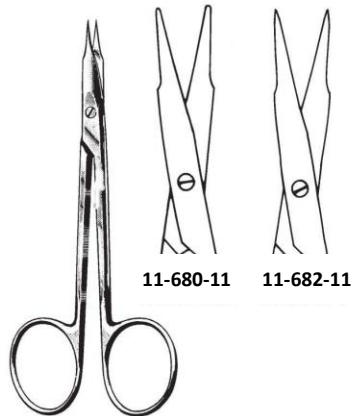

11-680-11 11-682-11

STEVENS TENOTOMY SCISSORS

- | |
|--------------------------------------|
| straight |
| 11-682-11 4 1/2" (108mm) blunt/blunt |
| 11-680-11 4 1/2" (108mm) sharp/sharp |
| curved |
| 11-683-11 4 1/2" (108mm) blunt/blunt |
| 11-681-11 4 1/2" (108mm) sharp/sharp |



GRADLE SCISSORS

- | |
|-------------------------------|
| 11-810-10 |
| 3 3/4" (95mm) slightly curved |
| sharp/sharp |



GRADLE SCISSORS

- | |
|----------------------------|
| 11-812-10 |
| 4" (102mm) slightly curved |
| ribbon type, sharp/sharp |

SUTURE SCISSORS



SHORTBENT STITCH SCISSORS
11-817-09
3 ½" (89mm)
curved on side
delicate

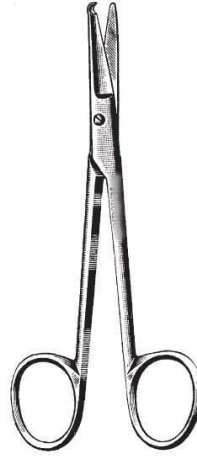

SPENCER STITCH SCISSORS	
11-824-09	11-826-13
3 ½" (89mm)	4 ¾" (121mm)
delicate	delicate
straight	straight

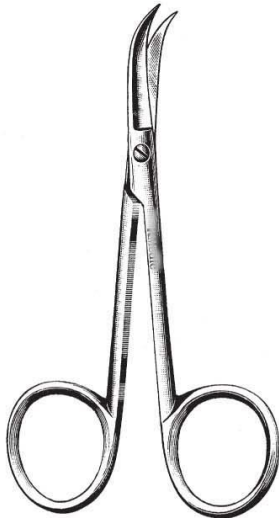

HILL STITCH SCISSORS
11-828-11
4 ½" (108mm)

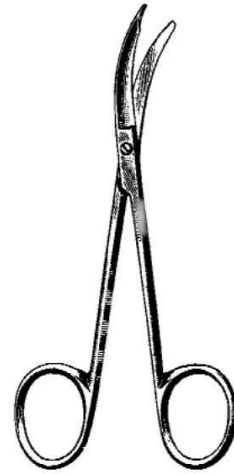

NORTHBENT STITCH SCISSORS
11-819-13
4 ¾" (121mm)
curved on side

SUTURE AND WIRE CUTTING SCISSORS

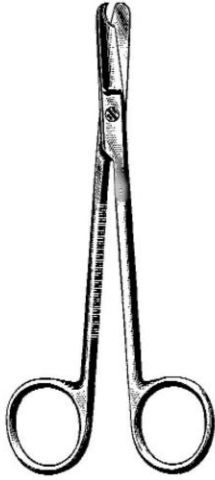

LITTAUER STITCH SCISSORS
 11-834-14
 5 1/2" (140mm)

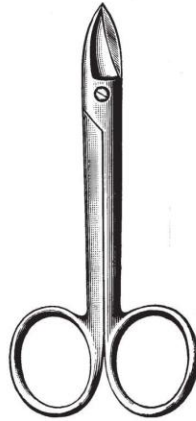

WIRE CUTTING SCISSORS 4" (102mm)
 straight
 11-874-10 smooth
 11-878-12
 one serrated blade



11-874-10

curved
 11-875-10 smooth
 11-879-12
 one serrated blade



WIRE CUTTING SCISSORS 4 1/2" (121mm)
 11-865-12
 one serrated
 blade, angular

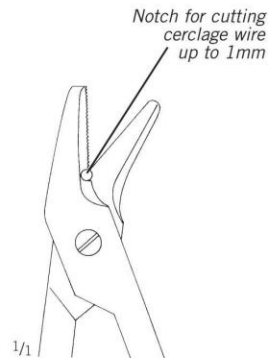

11-865-12

11-995-12
 one serrated
 blade, angular
 carbide

BANDAGE AND UTILITY SCISSORS

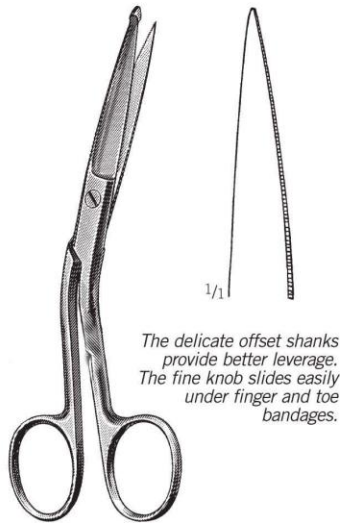

The delicate offset shanks provide better leverage. The fine knob slides easily under finger and toe bandages.

HI-LEVEL BANDAGE SCISSORS
 21-110-14
 5 ½" (140mm) shanks angled on side
 one serrated blade

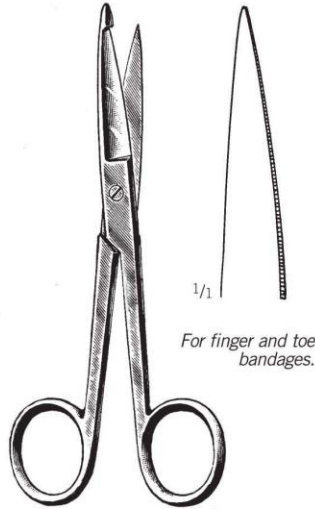

For finger and toe bandages.

KNOWLES BANDAGE SCISSORS
 21-114-14
 5 ½" (140mm) straight
 one serrated blade



21-165-14

LISTER BANDAGE SCISSORS
 21-165-09 3 ½" (89mm)
 21-165-11 4 ½" (114mm)
 21-165-14 5 ½" (140mm)
 21-165-18 7 ¼" (184mm)
 21-167-20 8" (203mm) one large finger ring



UTILITY SCISSORS one serrated blade
 21-209-18
 7 ½" (191mm)
 With autoclavable plastic finger rings.

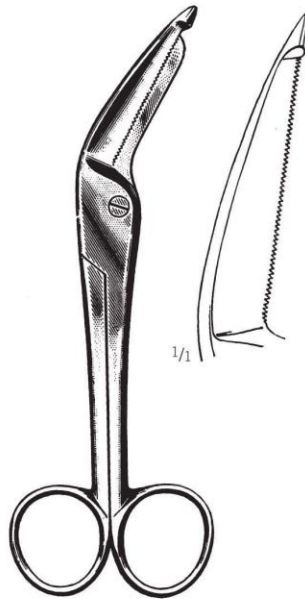

HERCULES SCISSORS
 21-120-18
 7 ½" (191mm) heavy duty
 one serrated blade



UTILITY SHEARS
 21-124-20
 8" (203mm) with wire cutting notch
 one serrated blade

PROBES AND SUCTION TUBES



PROBE WITH EYE malleable stainless
 16-108-11 4½" (114mm)
 16-108-12 5" (127mm)
 16-108-14 5½" (140mm)
 16-108-16 6" (152mm)
 16-108-20 8" (203mm)
 16-108-25 10" (254mm)
 16-108-30 12" (305mm)

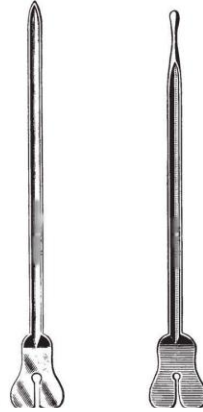

GROOVED DIRECTORS
 with tongue tie
 16-160-11 4½" (114mm)
 16-160-12 5" (127mm)
 16-160-14 5½" (140mm)
 with probe and tongue tie
 16-170-12 5" (127mm)
 16-170-14 5½" (140mm)
 16-170-15 6" (152mm)



1 french = .33mm
BARON SUCTION TUBE 5 ½" (140mm)
 18-528-10 3 french
 18-528-15 5 french
 18-528-20 7 french



1 french = .33mm
FRAZIER SUCTION TUBE 7" (178mm)
 18-523-06 6 french
 18-523-07 7 french
 18-523-08 8 french
 18-523-10 10 french
 18-523-12 12 french



YANKAUER SUCTION TUBE
 18-545-11 18-545-13
 11 ½" (292mm) front tip only
 chrome



1 french = .33mm
POOLE SUCTION TUBE 9" (229mm)
 chrome
 18-550-22 18-551-22
 23 french curved 30 french straight

SUTURE INSTRUMENTS



**WACHENFELDT CLIP APPLYING
 AND REMOVING FORCEPS**
 20-924-12
 5" (127mm)



MICHEL CLIP APPLYING FORCEPS
 20-916-12
 5" (127mm)



**WACHENFELDT CLIP APPLYING
 AND REMOVING FORCEPS**
 20-926-12
 5" (127mm) cross action



**MICHEL CLIP APPLYING
 AND REMOVING FORCEPS**
 20-928-12
 5" (127mm) double ended



CASTROVIEJO MICRO TYING FORCEPS
 4" (102mm)
 straight,
 35-618-05
 0.12mm
 1x2 teeth
 with tying platform
 35-618-10
 0.5mm
 1x2 teeth

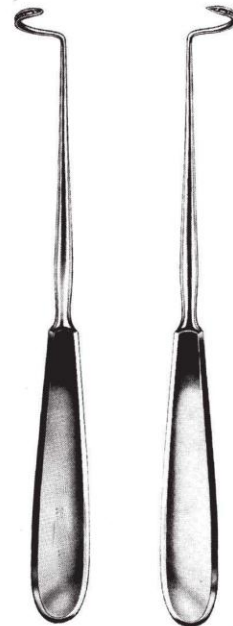

DESCHAMPS LIGATURE CARRIER
 8" (203mm)
 20-841-20 blunt left
 20-842-20 blunt right
 20-843-20 sharp left
 20-844-20 sharp right

HEMOSTATIC FORCEPS

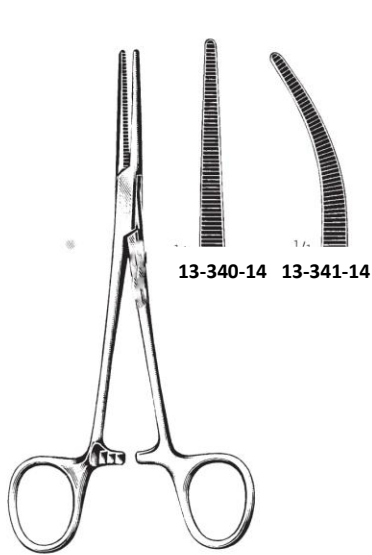

13-340-14 13-341-14

CRILE FORCEPS

straight
13-340-14 5 1/2"
13-342-14 5 1/2" (1 x 2)

curved
13-341-14 5 1/2" (140mm)
13-343-14 5 1/2" (140mm) (1 x 2)

Crile-Rankin
13-346-16 6 3/4"

13-347-14 6 3/4" (159mm)

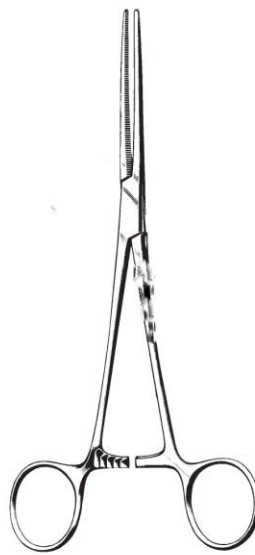

13-374-14

13-375-14

straight
13-410-14 5 1/2"
13-410-16 6 3/4"
13-410-18 7 1/4"
13-410-20 8"
13-410-23 9"
13-410-25 10"
13-410-30 12"

curved
13-411-14 5 1/2" (140mm)
13-411-16 6 3/4" (159mm)
13-411-18 7 1/4" (184mm)
13-411-20 8" (203mm)
13-411-23 9" (229mm)
13-411-25 10" (254mm)
13-411-30 12" (305mm)

ROCHESTER PEAN FORCEPS



13-324-14 13-325-14

PROVIDENCE HOSPITAL FORCEPS
13-324-14 5 1/2" (140mm) straight
13-325-14 5 1/2" (140mm) curved

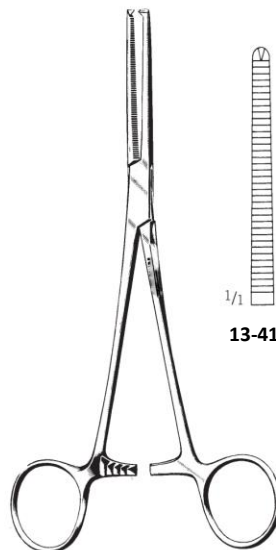

13-414-14 13-415-14 13-414-18 13-415-18

ROCHESTER-OSHSNER FORCEPS 1x2 teeth

straight
13-414-14 5 1/2"
13-414-16 6 3/4"
13-414-18 7 1/4"
13-414-20 8"
13-414-23 9"
13-414-25 10"
13-414-30 12"

curved
13-415-14 5 1/2" (140mm)
13-415-16 6 3/4" (159mm)
13-415-18 7 1/4" (184mm)
13-415-20 8" (203mm)
13-415-23 9" (229mm)
13-415-25 10" (254mm)
13-415-30 12" (305mm)

HEMOSTATIC FORCEPS

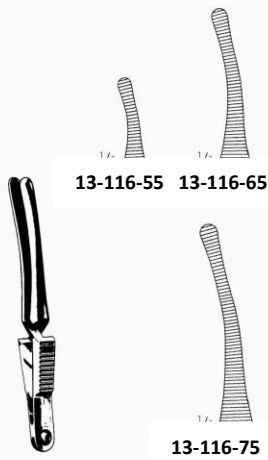

JOHNS HOPKINS BULLDOG CLAMPS

straight	curved
13-115-38 1 1/2"	13-116-38 1 1/2" (38mm)
13-115-55 2"	13-116-55 2" (51mm)
13-115-65 2 1/2"	13-116-65 2 1/2" (64mm)
13-115-75 3"	13-116-75 3" (76mm)
13-115-90 3 1/2"	13-116-90 3 1/2" (89mm)

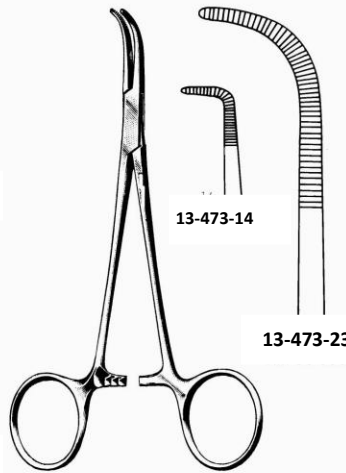

MIXTER FORCEPS fully curved

13-473-14 5 1/4" (133mm) delicate
13-473-16 6 1/4" (159mm)
13-473-18 7 1/4" (184mm)
13-473-23 9" (229mm)

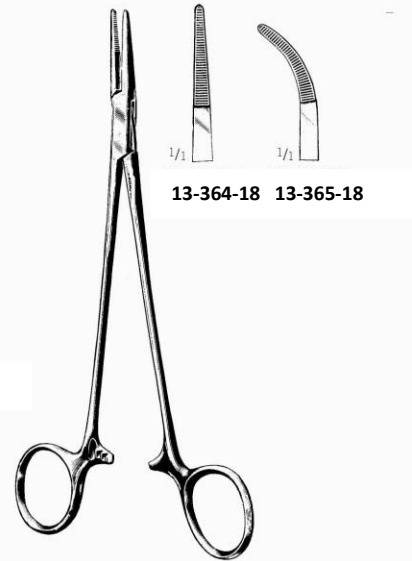

ADSON HEMOSTATIC FORCEPS

13-364-18 7 1/4" (184mm) straight	13-365-18 7 1/4" (184mm) curved
-----------------------------------	---------------------------------

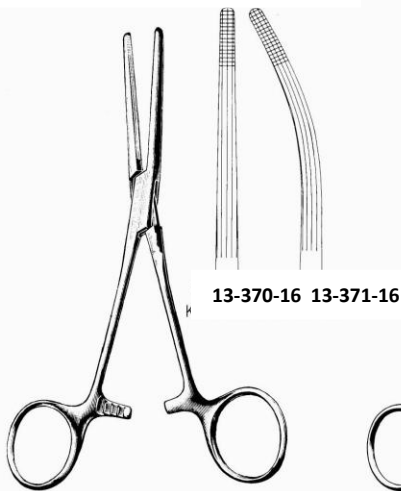

ROCHESTER-CARMALT FORCEPS

straight	curved
13-370-16 6 1/4"	13-371-16 6 1/4" (159mm)
13-370-20 8"	13-371-20 8" (203mm)

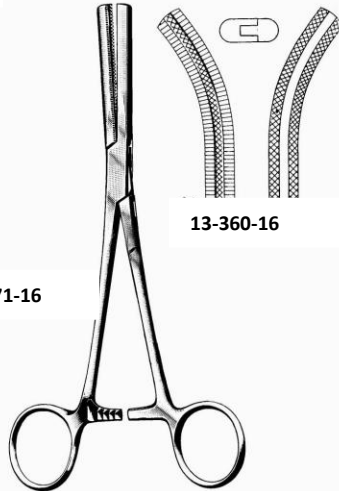

FERGUSON ANGIOTRIBE FORCEPS

straight	curved
13-360-16 6 1/2"	13-361-16 6 1/2" (165mm)
13-360-18 7 1/2"	13-360-18 7 1/2" (191mm)

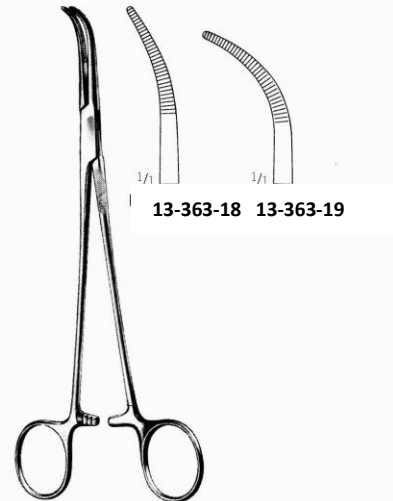

SCHNIDT FORCEPS

13-363-18 7 1/2" (191mm) half curved	13-363-19 7 1/2" (191mm) full curved
--------------------------------------	--------------------------------------

INTESTINAL FORCEPS



30-130-12

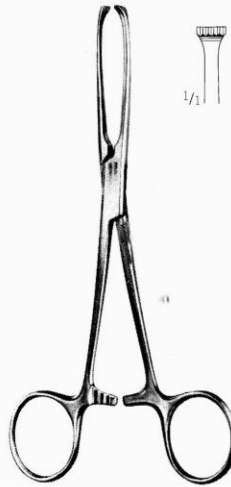

1/4



1/4

ALLIS TISSUE FORCEPS

- 30-130-12 4 3/4" (4x5 teeth delicate (121mm))
- 30-130-14 5 3/4" (4x5 teeth delicate (146mm))
- 30-128-15 6" (3x4 teeth standard (152mm))
- 30-130-15 6" (4x5 teeth standard (152mm))
- 30-134-15 6" (5x6 teeth standard (152mm))

ALLIS TISSUE FORCEPS

- 30-134-19
- 7 1/2" (191mm) 5x6 teeth

ALLIS-JUDD TISSUE FORCEPS

- 30-148-15
- 6" (152mm) 3x4 teeth



30-192-16



LAHEY VULSELLUM FORCEPS

- 27-449-15
- 6 1/4" (159mm) 3x3 prongs



30-275-23

BABCOCK FORCEPS

- 30-192-16 6 3/4" (159mm)
- 30-192-20 8" (203mm)
- 30-192-24 9 1/2" (241mm)

DOYEN CLAMP longitudinal serrations

- 30-274-23 9" (229mm) straight
- 30-275-23 9" (229mm) curved

TUBING AND UTILITY FORCEPS

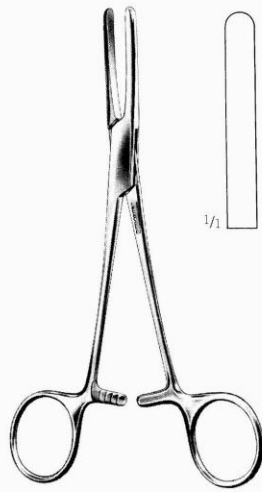

**PRESBYTERIAN TUBE
OCCLUDING FORCEPS**
13-942-16
7" (178mm) smooth

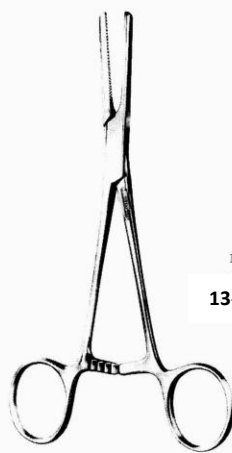

13-944-18

VORSE TUBE OCCLUDING FORCEPS
serrated
13-944-14 5 1/2" (140mm)
13-944-18 7 1/4" (184mm)
13-944-20 8" (203mm)



13-946-18

VORSE TUBE OCCLUDING FORCEPS
serrated, with guard
13-946-14 5 1/2" (140mm)
13-946-18 7 1/4" (184mm)
13-946-20 8" (203mm)

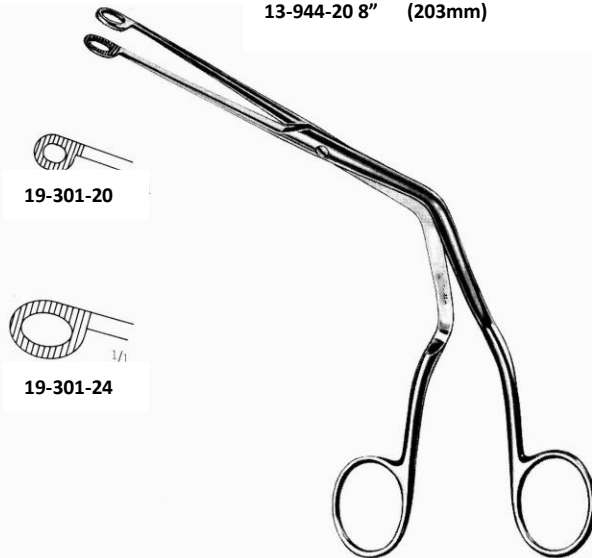

19-301-20

19-301-24

MAGILL ENDOTRACHEAL CATHETER INTRODUCING FORCEPS
19-301-20 7"(178mm) child
19-301-24 9"(229mm) adult

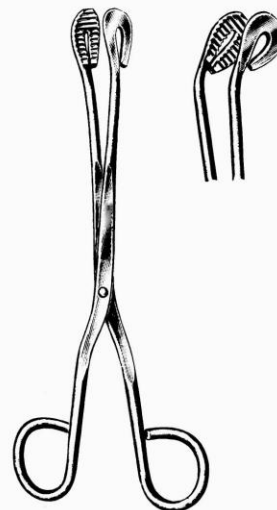

UTILITY AND STERILIZER FORCEPS
straight curved
55-094-20 8" 55-095-20 8" (203mm)
55-094-27 11" 55-094-27 11" (279mm)

TOWEL AND SPONGE FORCEPS



JONES TOWEL FORCEPS
13-881-05 13-881-09
2 ½" (64mm) 3 ¼" (83mm)



BACKHAUS TOWEL FORCEPS
13-915-08 13-915-13
3 ½" (89mm) 5 ¼" (133mm)

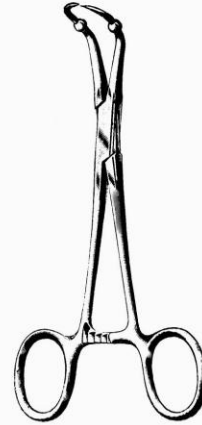

BACKHAUS-ROEDER TOWEL CLAMP
13-917-13
5 ¼" (133mm) with ball stops

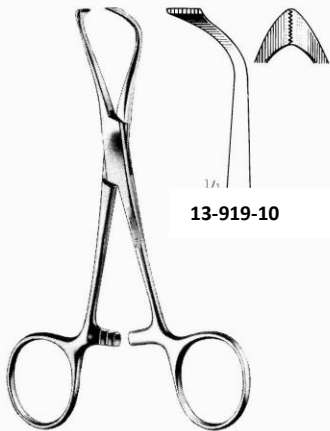

LORNA (EDNA) TOWEL CLAMP
13-919-10 13-919-13
4" (102mm) 5 ¾" (133mm)
non-perforating non-perforating

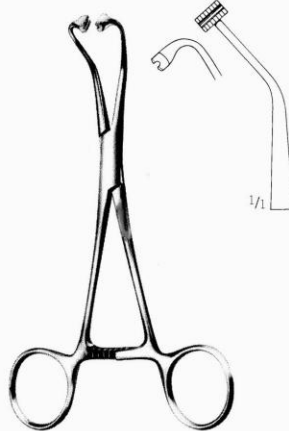

PEERS TOWEL CLAMP
13-916-15
5 ¾" (146mm)
non-perforating

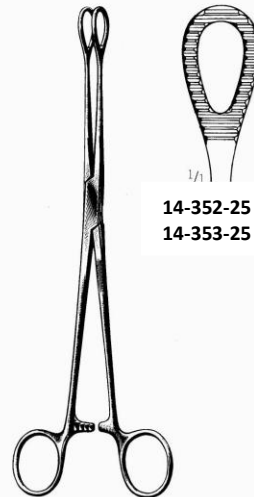

FOERSTER SPONGE FORCEPS
straight, serrated curved, serrated
14-352-18 7" 14-355-18 7" (178mm)
14-352-25 9 ¾" 14-355-25 9 ¾" (241mm)
straight, smooth curved, smooth
14-350-18 7" 14-353-18 7" (178mm)
14-350-25 9 ¾" 14-353-25 9 ¾" (241mm)

DRESSING AND TISSUE FORCEPS

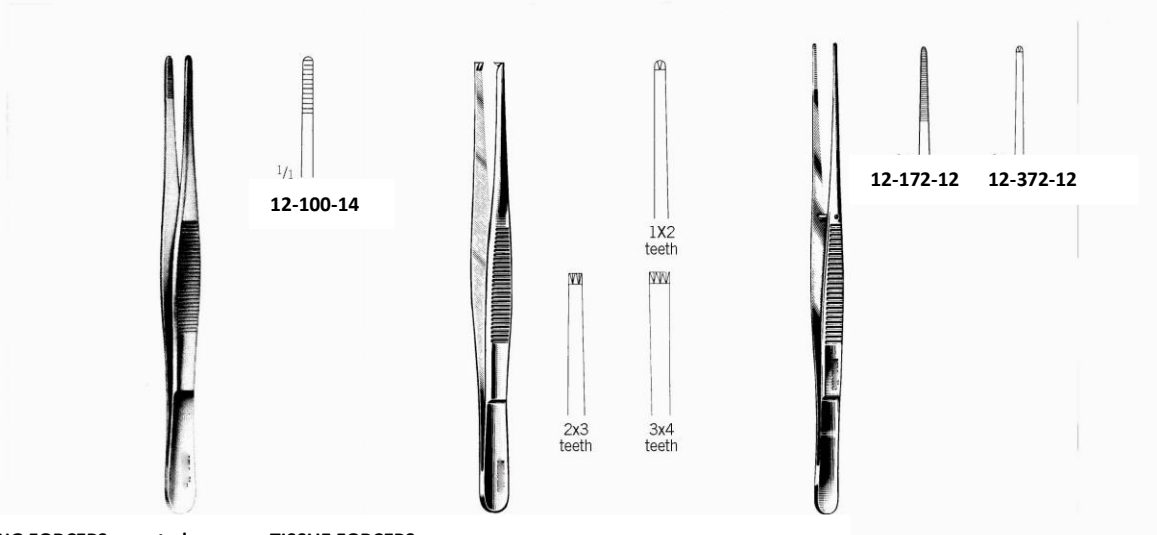

DRESSING FORCEPS serrated

- 12-100-11 4 1/2" (114mm)
- 12-100-13 5" (127mm)
- 12-100-14 5 1/2" (140mm)
- 12-100-6 6" (152mm)
- 12-100-8 8" (203mm)
- 12-100-10 10" (254mm)
- 12-100-12 12" (305mm)

TISSUE FORCEPS

- 1x2 teeth
 - 12-301-11 4 1/2" (114mm)
 - 12-301-11 5" (127mm)
 - 12-301-11 5 1/2" (140mm)
 - 12-301-11 6" (152mm)
 - 12-301-11 8" (203mm)
 - 12-301-11 10" (254mm)
 - 12-301-11 12" (305mm)

- 2x3 teeth
 - 12-302-13 5" (127mm)
 - 12-302-14 5 1/2" (140mm)
- 3x4 teeth
 - 12-303-14 5 1/2" (140mm)

SEMKEN FORCEPS

- serrated
 - 12-172-12 5" (127mm)
 - 12-172-15 6" (152mm)
- 1x2 teeth
 - 12-372-12 5" (127mm)
 - 12-372-15 6" (152mm)

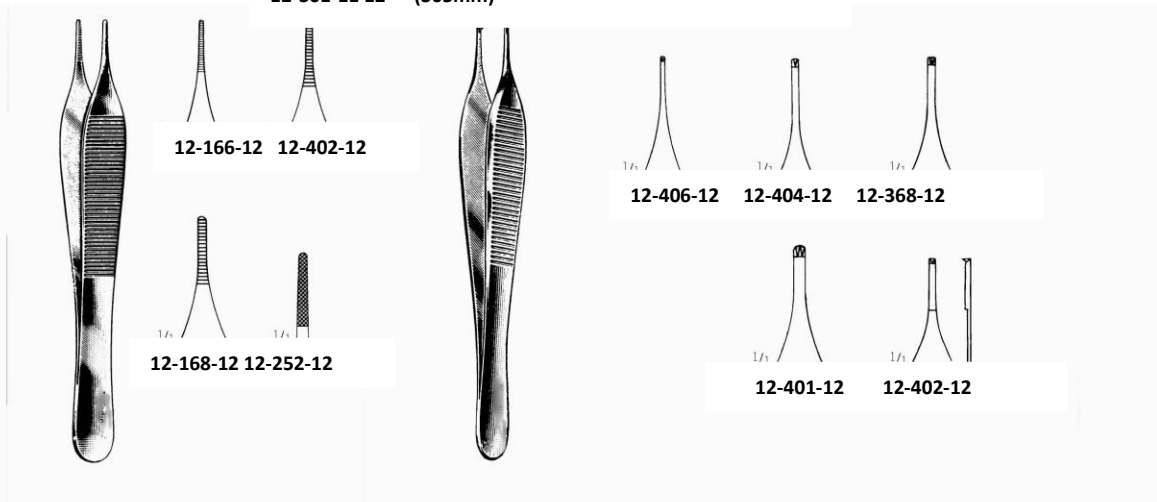

ADSON DRESSING FORCEPS

- 4 3/4" (121mm) serrated
 - 12-166-12 micro tip
 - 12-402-12 delicate tip
 - 12-168-12 standard tip
 - 12-252-12 carbide tip

ADSON TISSUE FORCEPS 4 3/4" (121mm)

- 1x2 teeth
 - 12-406-12 micro tip
 - 12-404-12 delicate tip
 - 12-368-12 standard tip
- 2x3 teeth
 - 12-401-12
- 12-405-12 delicate, with tying platform

DRESSING AND TISSUE FORCEPS

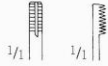

ADSON BROWN TISSUE FORCEPS
 12-403-12
 4 3/4" (121mm) 9x9 teeth
 side grasping

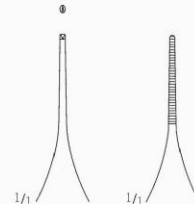

12-402-15 12-166-15

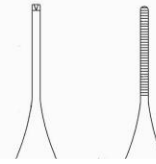

12-368-15 12-168-15

ADSON DRESSING AND TISSUE FORCEPS 6" (152mm)
 12-406-15 micro 1x2 teeth
 12-166-15 micro serrated
 12-368-15 1x2 teeth
 12-168-15 serrated



12-120-14

DRESSING FORCEPS
 serrated with fluted handles
 12-120-11 4 1/2" (114mm)
 12-120-13 5" (127mm)
 12-120-14 5 1/2" (140mm)
 12-120-15 6" (152mm)



TISSUE FORCEPS
 1x2 teeth with fluted handles
 11-321-11 4 1/2" (114mm)
 11-321-13 5" (127mm)
 11-321-14 5 1/2" (140mm)
 11-321-15 6" (152mm)

DRESSING AND TISSUE FORCEPS

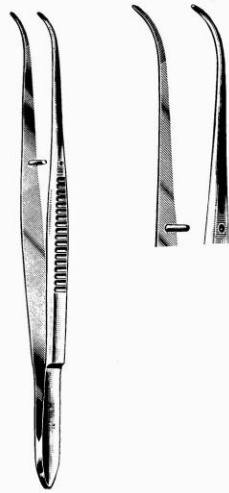

DRESSING FORCEPS
 12-127-13
 5" (127mm) curved
 fine point serrated



12-420-15

RUSSIAN TISSUE FORCEPS
 12-420-15 6" (152mm)
 12-420-20 8" (203mm)
 12-420-25 10" (254mm)

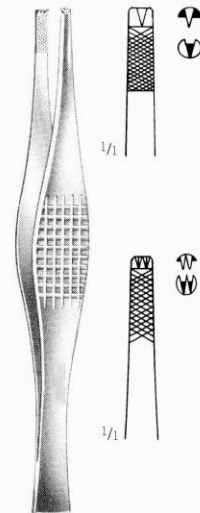

FERRIS-SMITH TISSUE FORCEPS
 7" (178mm) with platform
 12-451-18 1x2 teeth
 12-452-18 2x3 teeth

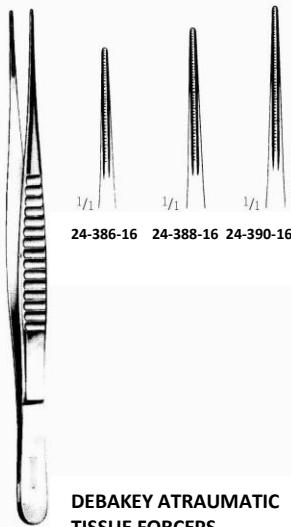

DEBAKEY ATRAUMATIC TISSUE FORCEPS
 24-386-16 6 1/4" (159mm) 1.5mm
 24-386-20 8" (203mm) 1.5mm
 24-386-24 9 1/2" (235mm) 1.5mm
 24-388-16 6 1/4" (159mm) 2.0mm
 24-388-20 8" (203mm) 2.0mm
 24-388-24 9 1/2" (235mm) 2.0mm
 24-390-16 6 1/4" (159mm) 3.5mm
 24-390-20 8" (203mm) 3.5mm
 24-390-24 9 1/2" (235mm) 3.5mm

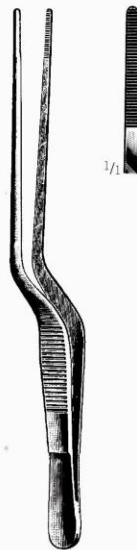

ADSON BAYONET FORCEPS
 12-178-21
 8 1/4" (210mm) straight
 with serrated tips



CUSHING BAYONET TISSUE FORCEPS 7 1/4" (184mm)
 12-383-17 1x2 teeth
 12-183-17 serrated

DRESSING AND TISSUE FORCEPS



35-360-10 35-361-10

35-364-10 35-365-10



12-503-10 12-505-10



35-365-10 35-366-10

GRAEFE EYE DRESSING FORCEPS

- 2 1/2' (64mm)
- 35-360-10 straight serrated
- 35-361-10 curved serrated
- 35-364-10 straight 1x2 teeth
- 35-365-10 curved 1x2 teeth

- EYE DRESSING FORCEPS 4" (102mm)**
 serrated
- 12-502-10 straight
 - 12-503-10 half curved
 - 12-505-10 full curved

- IRIS FORCEPS 4" (102mm)**
 1x2 teeth
- 35-364-10 straight
 - 35-365-10 half curved
 - 35-366-10 full curved



12-410-12
 #3
 4 1/2" (121 mm)



12-412-11
 #3C
 4 1/2" (111 mm)



12-416-11
 #4
 4 1/2" (111 mm)



12-414-11
 #5
 4 1/2" (111 mm)



12-413-11
 #6
 4 1/2" (121 mm)



12-409-12
 #7
 4 1/2" (121 mm)

SWISS JEWELERS STYLE FORCEPS

SPLINTER FORCEPS



12-630-07



12-601-07

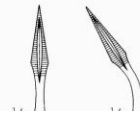

12-640-10 12-641-10

FEILCHENFELD FORCEPS serrated
12-630-07 12-630-11
3 1/2"(83mm) 4 1/2"(114mm)

PLAIN SPLINTER FORCEPS serrated
12-601-07 12-601-12
3 1/2"(89mm) 4 1/2"(114mm)

CARMALT SPLINTER FORCEPS serrated
12-640-10 12-641-10
4 1/2"(108mm) 4 1/2"(108mm)
Straight curved



1/1



12-720-13 12-721-13

VIRTUS SPLINTER FORCEPS
12-740-15
6"(152mm) straight
serrated

VANGUARD SPLINTER LIBERATOR
12-744-12
5"(127mm), trocar in trocar point only
reversible handle

WILLIAMS SPLINTER FORCEPS serrated
12-720-13 5 1/2" (140mm) straight
12-721-13 5 1/4"(133mm) 45 degree angled
12-722-13 5 1/2" (140mm) 90 degree angled

NEEDLE HOLDERS

Our carbide needle holders have TC inserts firmly bonded to the inside of both jaws. We guarantee them for three years. The surface profiles of the inserts have been precision milled to provide the surgeon with a firm, non-slip grip on the needle. Because the carbide is harder than the steel of the needles, carbide needle holders last much longer than ordinary ones. The finger rings are gold plated for easy identification.

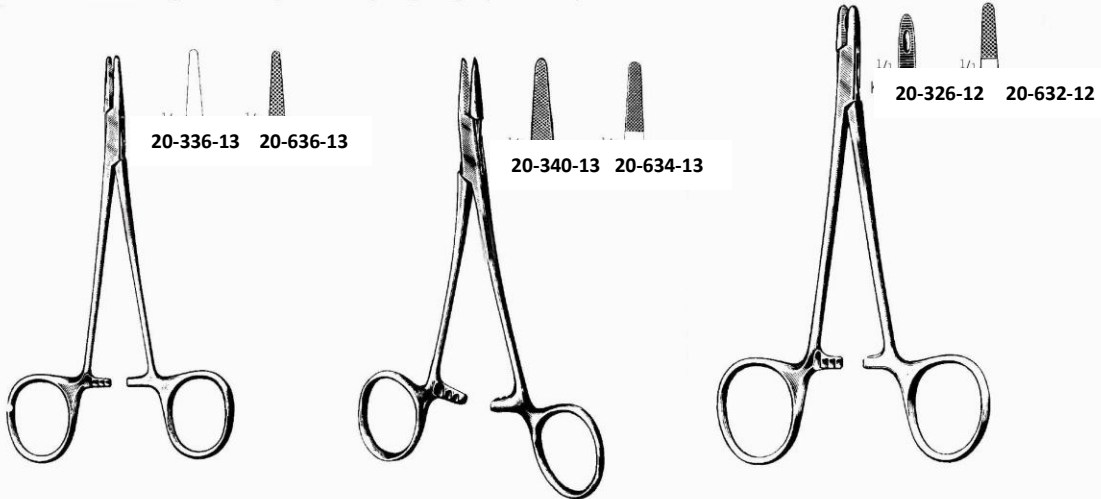

HALSEY NEEDLE HOLDER

- 20-336-13 5" (127mm) smooth
- 20-636-13 5" (127mm) smooth carbide
- 20-337-13 5 1/4" (133mm) serrated
- 20-637-13 5" (127mm) serrated carbide

HEGAR BAUMGARTNER NEEDLE HOLDER

- 20-340-13 5" (127mm) serrated
- 20-340-14 5 3/4" (146mm) serrated
- 20-634-13 5" (127mm) serrated carbide

DERF NEEDLE HOLDER

- 20-326-12 4 3/4" (121mm) horizontal serrations
- 20-632-12 4 3/4" (121mm) carbide cross serrations



WEBSTER NEEDLE HOLDER smooth

- 20-334-13 5" (127mm)
- 20-637-12 5" (127mm) carbide

COLLIER NEEDLE HOLDER

- 20-332-12 5" (127mm) fenestrated jaws serrated

NIEVERT NEEDLE HOLDER

- smooth, 20-338-13 5" (127mm)
- one offset finger ring 20-635-13 5" (127mm) carbide

NEEDLE HOLDERS

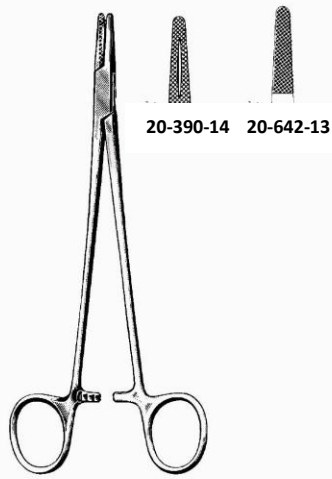

20-390-14 20-642-13



20-344-13

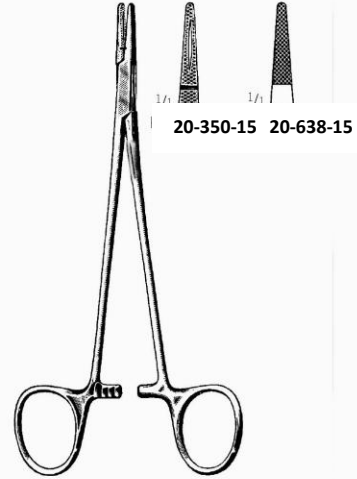

20-350-15 20-638-15

MAYO HEGAR NEEDLE HOLDER serrated carbide
 20-390-14 5 1/4" (133mm) 20-642-13 5" (127mm)
 20-390-15 6" 20-642-15 6" (152mm)
 20-390-18 7" 20-642-18 7" (178mm)
 20-390-20 8" 20-642-20 8" (203mm)
 20-390-26 10 1/2" 20-642-26 10

BROWN NEEDLE HOLDER fine serrations
 20-344-13 5 1/4" (133mm) convex jaws
 20-344-18 7 1/2" (184mm) convex jaws

CRILE-WOOD (DEBAKEY) NEEDLE HOLDER
 serrated carbide
 20-350-15 6" 20-638-15 6" (152mm)
 20-350-18 7" 20-638-18 7" (178mm)
 20-350-20 8" 20-638-20 8" (203mm)
 20-350-23 9" 20-638-23 9" (229mm)

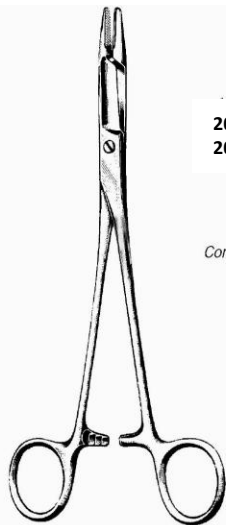

OLSEN-HEGAR NEEDLE HOLDER

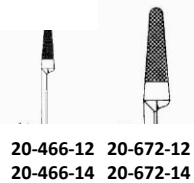

Combination needle holder and suture scissors.

20-466-12 4 3/4" (121mm) delicate serrated*
 20-467-12 4 3/4" (121mm) delicate smooth*
 20-466-14 5 1/2" (140mm) serrated
 20-466-16 6 1/2" (165mm) serrated
 20-466-19 7 1/2" (191mm) serrated carbide
 20-672-12 4 3/4" (121mm) delicate serrated*
 20-673-12 4 3/4" (121mm) delicate smooth*
 20-672-14 5 1/2" (140mm) serrated
 20-672-16 6 1/2" (165mm) serrated
 20-672-19 7 1/2" (191mm) serrated

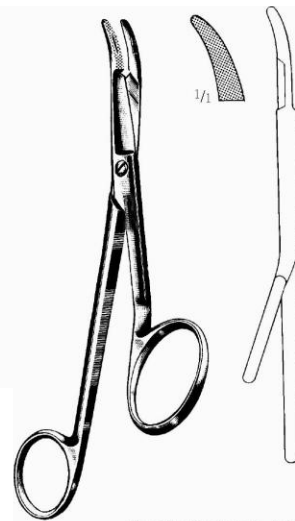

Combination needle holder and suture scissors.

GILLIES NEEDLE HOLDER
 20-469-16
 6 1/2" (165mm) curved
 one fenestrated jaw
 one angled finger ring

NEEDLE HOLDERS



20-352-18



20-654-13



20-652-13

SAROT NEEDLE HOLDER serrated carbide

20-352-18 7 1/2" 20-640-18 7 1/2" (191mm)
20-352-26 10 1/2" 20-640-26 10 1/2" (267mm)

RYDER NEEDLE HOLDER serrated carbide

20-654-13 5" (127mm) 20-654-20 8" (203mm)
20-654-15 6" (152mm) 20-654-23 9" (229mm)
20-654-18 7" (178mm) 20-654-26 10 1/4" (260mm)

RYDER MICRO NEEDLE HOLDER serrated carbide

20-652-13 5" (127mm) 20-652-20 8" (203mm)
20-652-15 6" (152mm) 20-652-23 9" (229mm)
20-652-18 7" (178mm)

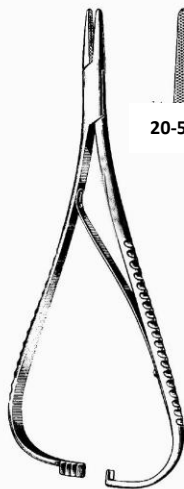

20-516-14



20-306-14 20-307-14



20-304-01 20-305-01

MATHIEU NEEDLE HOLDER serrated carbide

20-516-14 20-674-14
5 1/2" (140mm) 5 1/2" (140mm) carbide

CASTROVIEJO MICRO NEEDLE HOLDER

5 1/2" (140mm) smooth, with lock carbide
20-306-14 straight 20-620-00 straight
20-307-14 curved 20-620-01 curved

CASTROVIEJO MICRO NEEDLE HOLDER

5 1/2" (140mm) extra delicate, smooth, with lock
20-304-01 straight
20-305-01 curved

SKIN HOOKS

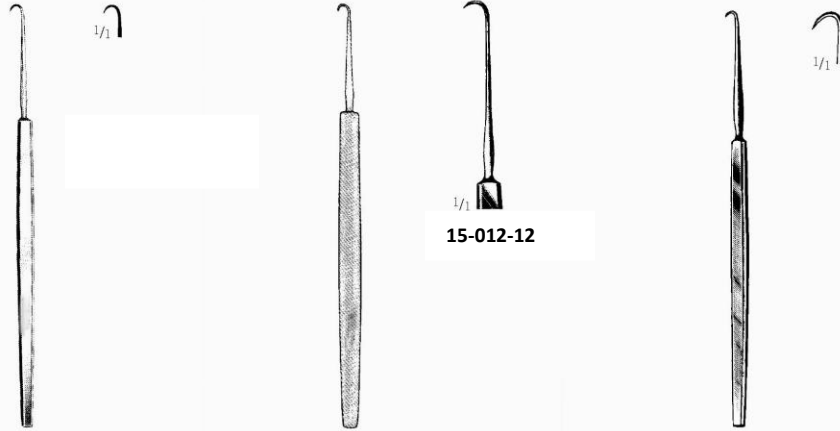

PRIMAX SKIN HOOK
 15-010-12
 4 3/4" (121mm) one sharp prong
 2mm diameter

WIENER SKIN HOOK 5" (127mm)
 15-012-12 15-013-12
 one sharp prong one blunt prong
 3.5mm diameter 3.5mm diameter

COTTLE SKIN HOOK
 37-686-03
 5 1/2" (140mm) one sharp prong
 large deep curve 4mm diameter

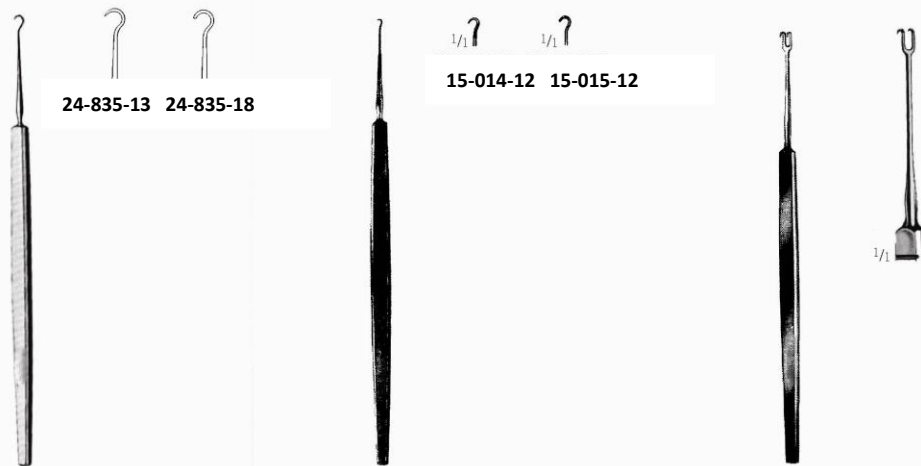

FRAZIER HOOK 5" (127mm)
 24-835-13 24-835-18
 one sharp prong one blunt prong
 2.5mm diameter 2.5mm diameter

TYRELL HOOK 5" (127mm)
 15-014-12 15-015-12
 one sharp prong one blunt prong
 1.5mm diameter 1.5mm diameter

GUTHRIE HOOK
 15-072-02
 5" (127mm) 2 sharp prongs
 2.5mm wide

SKIN HOOKS AND FINGER RETRACTORS

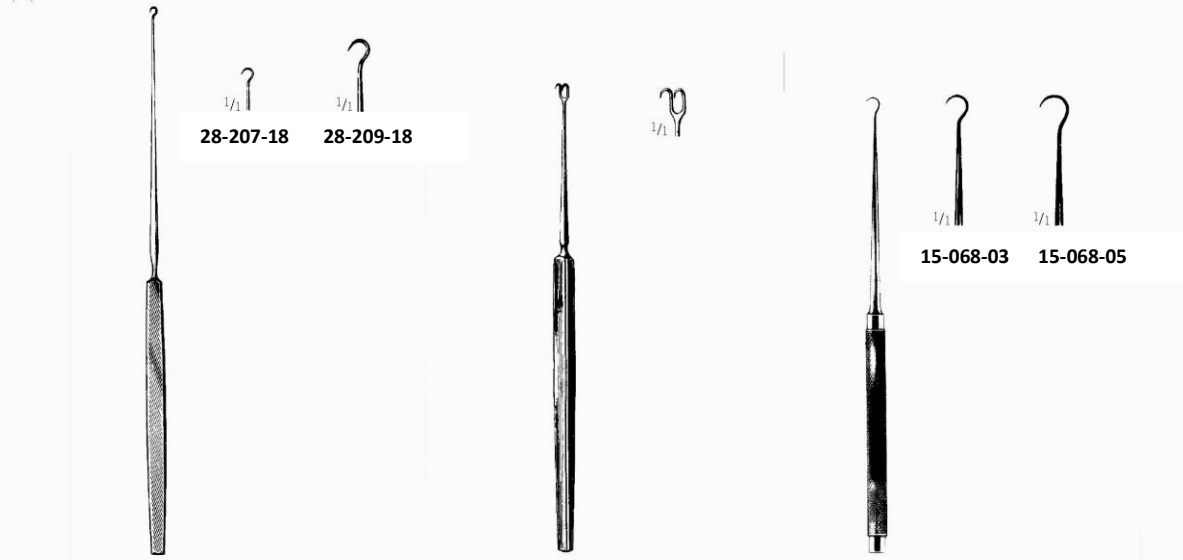

GILLIES HOOK 7" (178mm)
 28-207-18 2mm diameter
 28-209-18 3mm diameter

FREER SKIN HOOK 6" (152mm)
 37-702-15 2 sharp prongs 2mm wide
 37-703-15 2 blunt prongs 2mm wide

KLEINERT-KUTZ HOOK 6" (152mm)
 15-068-03 3mm diameter
 15-068-05 5mm diameter
 15-068-07 7mm diameter

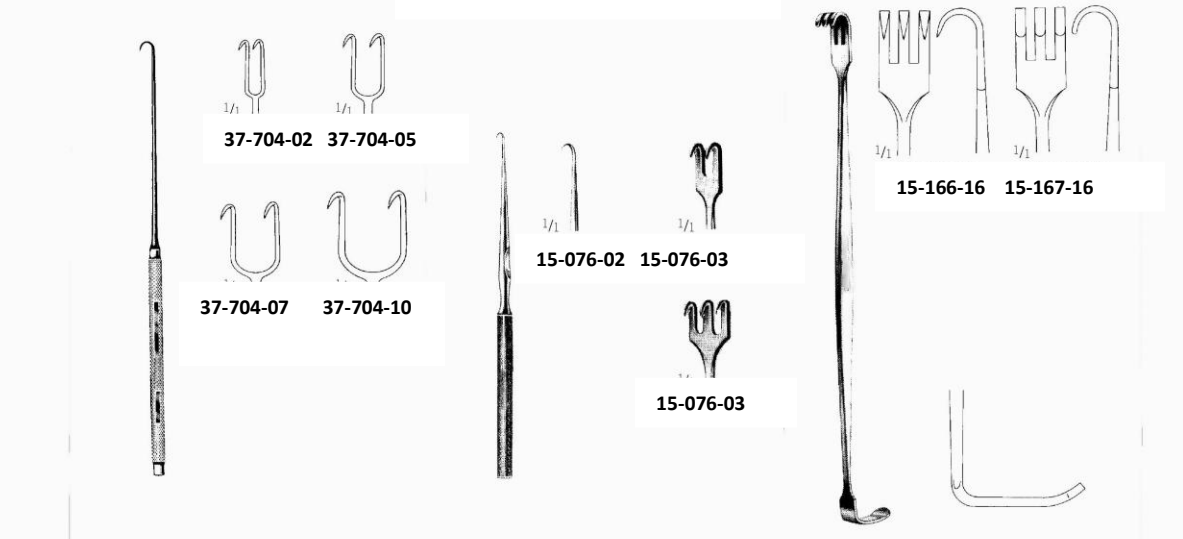

JOSEPH HOOK 6 1/4" (159mm) sharp
 37-704-01 1 prong
 37-704-02 2 prongs 2mm wide
 37-704-05 2 prongs 5mm wide
 37-704-07 2 prongs 7mm wide
 37-704-10 2 prongs 10mm wide

LAHEY RETRACTOR 4 3/4" (121mm)
 15-076-01 1 sharp prong
 15-076-02 2 sharp prongs
 15-076-03 3 sharp prongs

SENN RETRACTOR 3 prongs
 15-166-16 6 1/4" (159mm) sharp
 15-167-16 6 1/4" (159mm) blunt

FINGER RETRACTORS

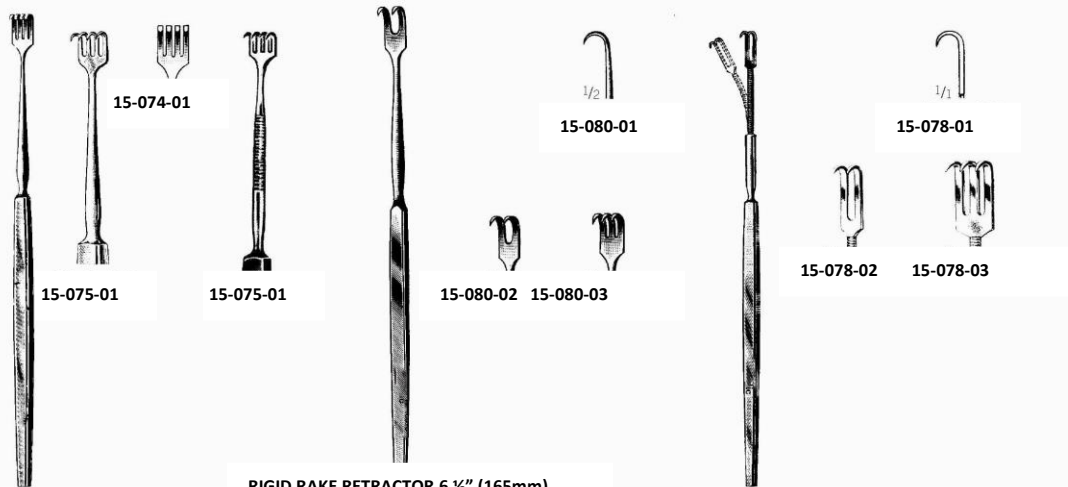

BLAIR (ROLLET) RETRACTOR
5 1/2" (140mm)
15-074-01 4 sharp prongs, rigid
15-075-01 4 blunt prongs, rigid
15-076-01 4 sharp prongs, flexible

RIGID RAKE RETRACTOR 6 1/2" (165mm)
15-080-01 1 sharp prong
15-080-02 2 sharp prongs
15-080-03 3 sharp prongs
15-081-03 1 blunt prong
15-081-03 2 blunt prongs
15-081-03 3 blunt prongs

FLEXIBLE RAKE RETRACTOR 6 1/4" (159mm)
15-078-01 1 sharp prong
15-078-02 2 sharp prongs
15-078-03 3 sharp prongs
15-079-01 1 blunt prong
15-079-02 2 blunt prongs
15-079-03 3 blunt prongs



Fine cross serrations help prevent slippage.

RAGNELL RETRACTOR
15-163-16
5 3/4" (146mm) double ended
4mm width x 8mm depth blade
and 6mm width x 15mm depth blade

RAGNELL RETRACTOR
15-164-16
5 3/4" (146mm) double ended WITH serrations
4mm width x 8mm depth blade
and 6mm width x 15mm depth blade

DAVIS RETRACTOR
15-165-16
6" (152mm) double ended
6mm width x 17mm depth blade
and 9mm width x 20mm depth blade

RETRACTORS

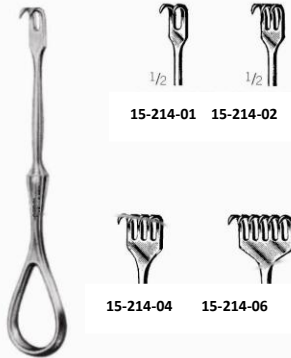

15-214-01 15-214-02



15-214-04 15-214-06

VOLKMAN RETRACTOR 4 1/2" (114mm)
sharp
15-214-02 2 prongs
15-214-03 3 prongs
15-214-04 4 prongs
15-214-06 6 prongs
blunt
15-216-01 2 prongs
15-216-03 3 prongs
15-216-06 6 prongs

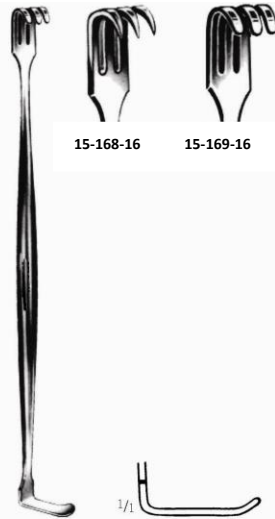

15-168-16 15-169-16

MATHIEU RETRACTOR 6 3/4" (159mm)
15-168-16 3 sharp prongs
15-169-16 3 blunt prongs



VOLKMAN RETRACTOR 8 1/2" (216mm) with ring handle

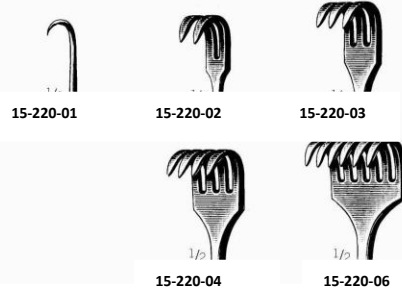

15-220-01 15-220-02 15-220-03
15-220-04 15-220-06

sharp
15-220-01 1 prong 10mm depth
15-220-02 2 prongs 8mm width X 10mm depth
15-220-03 3 prongs 13mm width X 10mm depth
15-220-04 4 prongs 18mm width X 10mm depth
15-220-06 6 prongs 28mm width X 10mm depth
blunt
15-222-01 2 prongs 8mm width X 10mm depth
15-222-03 3 prongs 13mm width X 10mm depth
15-222-04 4 prongs 18mm width X 10mm depth
15-222-06 6 prongs 28mm width X 10mm depth



JACKSON TRACHEAL HOOK
27-157-14
5 3/4" (146mm) sharp

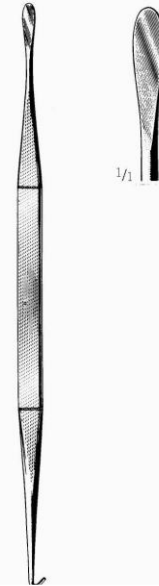

SMITHWICK HOOK AND DISSECTOR
24-780-12
12" (305mm) double ended

RETRACTORS



CRILE RETRACTOR
15-154-11
4 3/8" (111mm) double ended



MEYERDING FINGER RETRACTOR 7" (178mm)



15-151-01
#1



15-151-02
#2



15-151-03
#3



15-151-04
#4



15-151-05
#5



15-151-06
#6

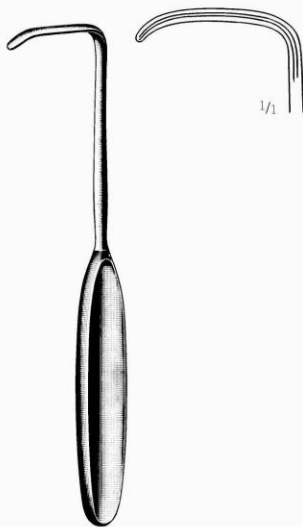

LAHEY RETRACTOR
15-307-19
7 3/4" (195mm)

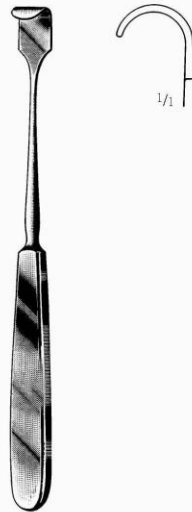

LITTLE RETRACTOR
15-313-20
7 3/4" (195mm)



24-694-19

LOVE NERVE RETRACTOR 8 1/2" (216mm)
24-694-19 7mm blade straight
24-695-19 7mm blade angled 45 degrees
24-697-19 7mm blade angled 90 degrees

RETRACTORS



GREEN RETRACTOR
 15-093-12
 8 1/2" (216mm) fenestrated handle



GOELET RETRACTOR
 15-695-00
 7 1/2" (191mm) double ended



CUSHING VEIN RETRACTOR
 15-172-08
 9" (229mm) fenestrated handle

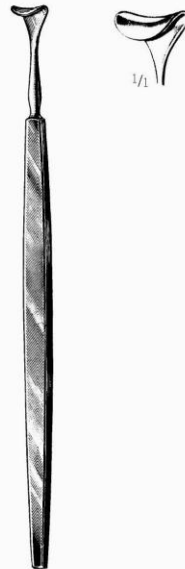

CUSHING VEIN RETRACTOR
 15-171-10
 8" (203mm) 10mm blade

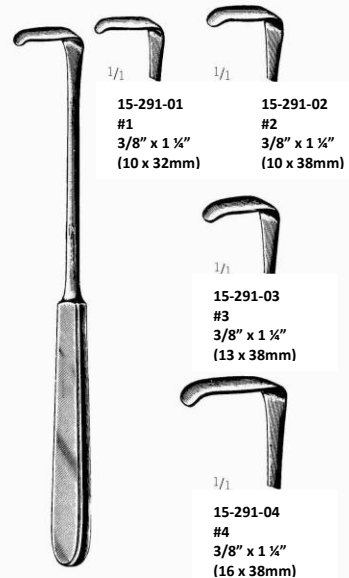

LANGENBECK RETRACTOR 8" (203mm)

15-291-01 #1 3/8" x 1 1/4" (10 x 32mm)
 15-291-02 #2 3/8" x 1 1/4" (10 x 38mm)

15-291-03 #3 3/8" x 1 1/4" (13 x 38mm)

15-291-04 #4 3/8" x 1 1/4" (16 x 38mm)

RETRACTORS



15-391-01



RICHARDSON RETRACTOR 91/2² (241mm)
 15-391-01 ¾" wide x 1" long blade
 (19mm wide x 25mm long blade)
 15-391-02 1" wide x 1 ¼" long blade
 (25mm wide x 32mm long blade)
 15-391-03 1 ½" wide x 1 ½" long blade
 (38mm wide x 38mm long blade)

RICHARDSON RETRACTOR
 15-395-24
 9 ½" (241mm)
 ¾" wide x 2" long blade
 (19mm wide x 51mm long blade)

**RICHARDSON-EASTMANN
 RETRACTOR**
 15-381-01 9 ½" (241mm) small
 15-381-02 10 ¼" (260mm) large
 15-381-03 set of two

RETRACTORS

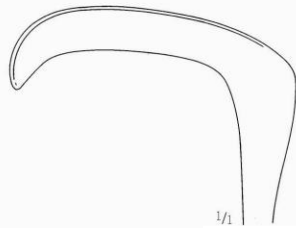

15-397-26

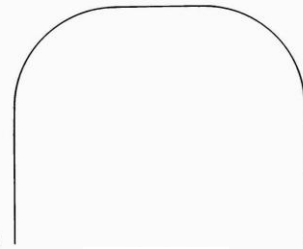

15-391-03



KELLY RETRACTOR 9 3/4" (248mm) with loop handle
 15-397-25 1 1/2" x 2" blade (38mm x 51mm)
 15-397-26 2" x 2 1/2" blade (51mm x 64mm)
 15-397-27 2 1/2" x 3" blade (64mm x 76mm)
 15-397-28 3" x 2 1/2" blade (76mm x 64mm)

DEAVER RETRACTOR hollow grip handle
 15-391-01 1" wide x 10" long blade (25mm x 254mm)
 15-391-02 1" wide x 12" long blade (25mm x 305mm)
 15-391-03 1" wide x 13" long blade (25mm x 330mm)
 15-391-04 2" wide x 12" long blade (51mm x 305mm)
 15-391-05 2 1/2" wide x 14 1/2" long blade (64mm x 368mm)
 15-391-06 3" wide x 12" long blade (76mm x 305mm)
 15-391-07 3 1/2" wide x 12" long blade (89mm x 305mm)

RETRACTORS

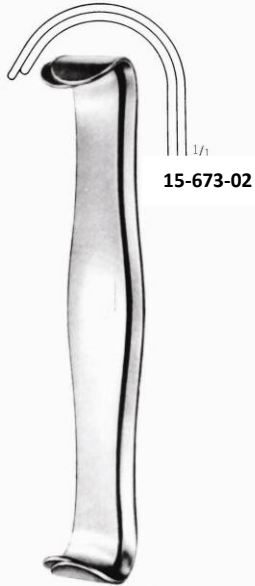

PARKER RETRACTOR
 double ended, set of two
 15-673-01 5" (127mm) set
 15-673-02 7 1/2" (184mm) set

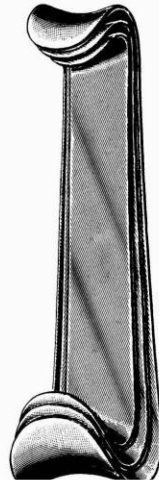

ROUX RETRACTOR
 15-655-01 5 1/4" (133mm) small
 3/4" x 1" (19mm x 25mm)
 15-655-02 5 3/4" (146mm) medium
 7/8" x 1 3/8" (22mm x 35mm)
 15-655-03 6 5/8" (173mm) large
 1" x 1 5/8" (25mm x 41mm)

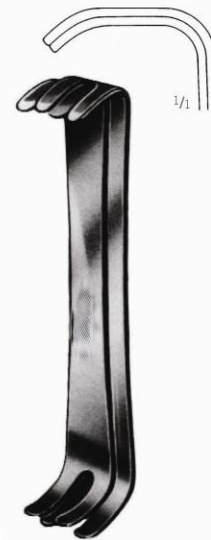

MAYO-COLLINS RETRACTOR
 15-680-15
 6" (152mm) double ended, set of two

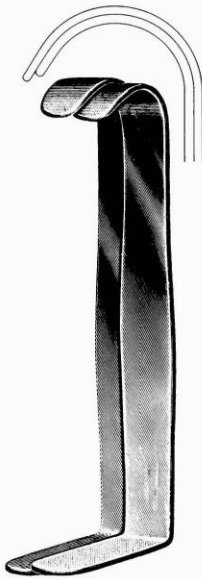

PARKER-MOTT RETRACTOR
 15-675-00
 6" (152mm) double ended, set of two



U.S. ARMY RETRACTOR
 15-687-00
 8 1/4" (210mm) double ended, set of two

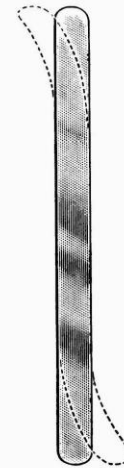

RIBBON RETRACTOR malleable
 15-975-13 6" x 1/2" (152mm x 13mm)
 15-975-25 7 1/2" x 1" (191mm x 25mm)
 15-975-19 13" x 3/4" (330mm x 19mm)
 15-976-25 13" x 1" (330mm x 25mm)
 15-975-32 13" x 1 1/4" (330mm x 32mm)
 15-975-38 13" x 1 1/2" (330mm x 38mm)
 15-975-51 13" x 2" (330mm x 51mm)

SELF-RETAINING RETRACTORS

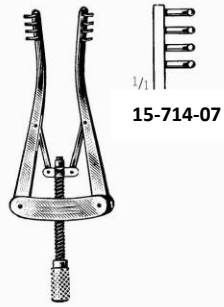

ALM RETRACTOR 4 blunt prongs
15-714-07 15-715-07
2 3/4" (70mm) 4" (102mm)

SELF RETAINING RETRACTORS
4" (102mm)
15-717-10 15-718-10
4 sharp prongs 4 blunt prongs

GELPI RETRACTOR sharp points
15-802-09 3 1/2" (89mm)
15-802-11 4 1/2" (114mm)
15-802-14 5 1/2" (140mm)
15-802-18 7 1/2" (191mm)
15-804-18 7" with ball stops (178mm)

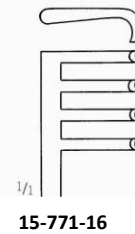
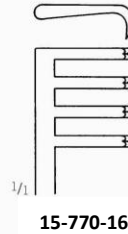
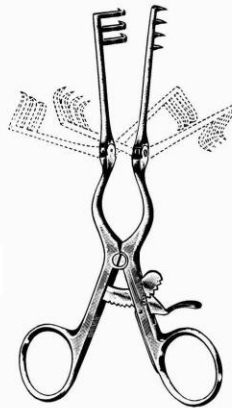
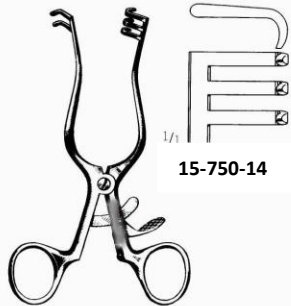

WEITLANER RETRACTOR

sharp points	blunt points
2x3 teeth	2x3 teeth
15-748-10 4"	15-749-10 4" (102mm)
3x4 teeth	3x4 teeth
15-750-14 5 1/2"	15-751-14 5 1/2" (140mm)
15-750-16 6 1/2"	15-751-16 6 1/2" (165mm)
15-750-20 8"	15-751-20 8" (203mm)
15-750-24 9 1/2"	15-751-24 9 1/2" (241mm)

BECKMAN-WEITLANER RETRACTOR hinged blades

3x4 sharp prongs	
15-770-14 5 1/2" (140mm)	15mm depth x 20mm height
15-770-16 6 1/2" (165mm)	15mm depth x 20mm height
15-770-20 8 1/2" (216mm)	17mm depth x 22mm height
15-770-24 9 1/2" (241mm)	24mm depth x 22mm height
3x4 blunt prongs	
15-771-14 5 1/2" (140mm)	15mm depth x 20mm height
15-771-16 6 1/2" (165mm)	15mm depth x 20mm height
15-771-20 8 1/2" (216mm)	17mm depth x 22mm height
15-771-24 9 1/2" (241mm)	24mm depth x 22mm height

SELF-RETAINING RETRACTORS

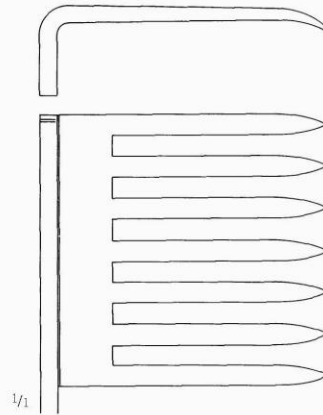

BECKMAN-EATON RETRACTOR
15-776-31
12 ½" (317mm)
hinged blades
7x7 sharp prongs
45mm depth x 45mm height

SELF-RETAINING RETRACTORS



15-778-32

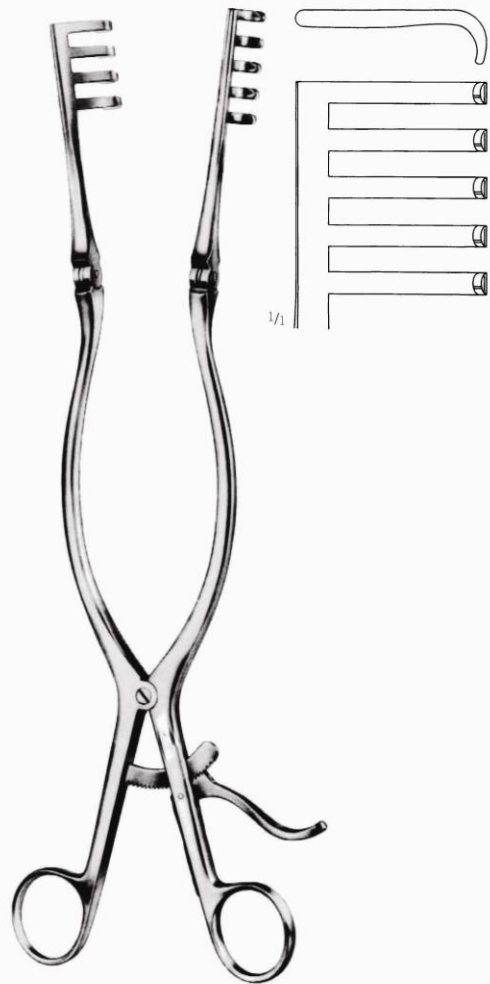

BECKMAN RETRACTOR
 15-778-32
 12 1/4" (311mm)
 with hinged blades
 4x4 sharp prongs
 17mm depth x 27mm height

15-779-32
 12 1/4" (311mm)
 with hinged blades
 4x4 blunt prongs
 17mm depth x 27mm height

ADSON RETRACTOR
 15-777-32
 13" (330mm)
 with hinged blades
 4x5 blunt prongs

RETRACTORS AND DILATORS

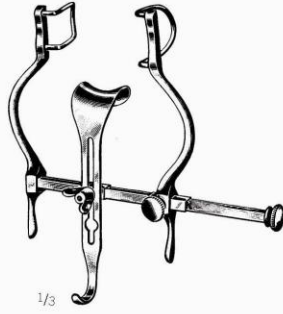

BALFOUR RETRACTOR Pediatric
15-850-00
3 1/2" (89mm) spread, fenestrated

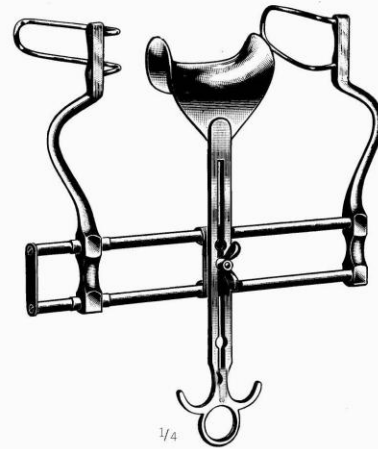

BALFOUR RETRACTOR Adult
15-856-00
7" (178mm) spread, fenestrated

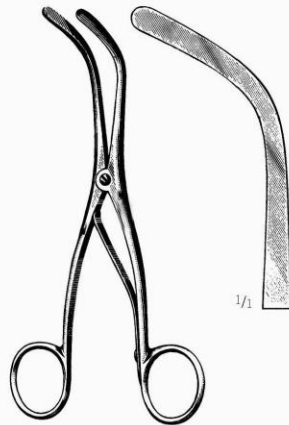

TROSSEAU DILATOR
27-115-14
5 1/2" (133mm) bi-valve

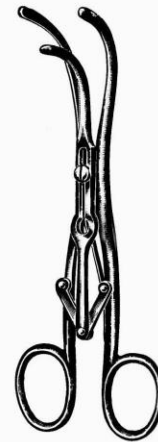

LA BORDE DILATOR
27-113-14
5 1/2" (140mm) tri-valve

ELEVATORS

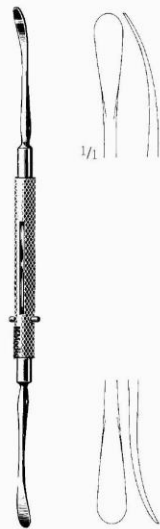

1/1



37-521-04

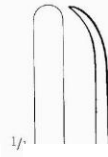

37-521-05



1/1

FREER ELEVATOR
37-545-18
7 1/2" (191mm) one sharp and
one blunt blade, 5mm wide

MCKENTY ELEVATOR 5 1/2" (140mm)
37-521-04 37-521-05
4mm wide 5mm wide

KEY PERIOSTEAL ELEVATOR
23-402-06 7" (178mm) 1/4" (6mm) wide
23-402-10 7 1/2" (191mm) 3/8" (10mm) wide
23-402-13 7 1/2" (191mm) 1/2" (13mm) wide
23-402-19 8" (203mm) 3/4" (19mm) wide
23-402-25 8 1/4" (210mm) 1" (25mm) wide



1/1
23-470-16

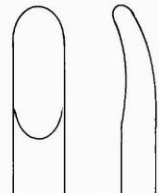

1/1
23-402-19

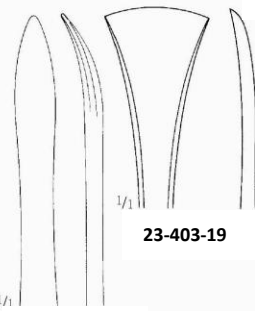

1/1
23-403-19



1/1
23-486-17 23-487-17

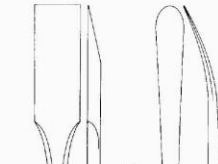

1/1
23-484-17 23-485-17

SAYRE PERIOSTEAL ELEVATOR
6 1/2" (165mm)
23-470-16
sharp
double ended

23-471-16
blunt
double ended

LANGENBECK PERIOSTEAL ELEVATOR
7" (178mm)
23-402-19 23-403-19
7mm wide 18mm wide
blunt edge sharp edge

ADSON PERIOSTEAL ELEVATOR
6 3/4" (171mm)
23-484-17 straight sharp
23-485-17 curved blunt
23-486-17 straight semi-sharp
23-487-17 curved semi-sharp

CURETTES

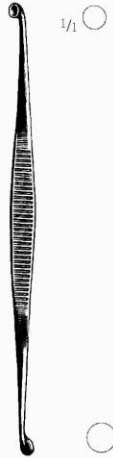

MARTINI BONE CURETTE
23-356-00
5 1/2" (140mm) double ended
4mm and 5mm round cups

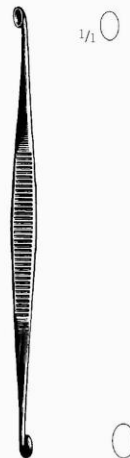

WILLIGER BONE CURETTE
23-358-00
5 1/2" (140mm) double ended
3mm and 4mm oval cups



VOLKMANN CURETTE
23-352-17
6 1/2" (165mm) double ended
oval cups

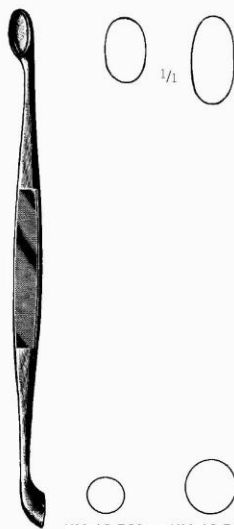

23-354-13 23-354-16

VOLKMANN CURETTE oval and round cups
23-354-13 5" (127mm) double ended
23-354-16 6 1/2" (165mm) double ended
23-354-20 8" (203mm) double ended



BRUN (SPRATT) CURETTE oval cup

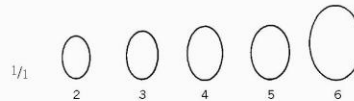
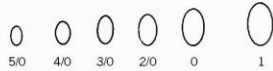

- | | |
|-------------------|-------------------|
| 7" (178mm) | 9" (229mm) |
| 23-308-10 #5/0 | 23-334-10 #3/0 |
| 23-308-20 #4/0 | 23-334-20 #2/0 |
| 23-308-30 #3/0 | 23-334-30 #0 |
| 23-308-40 #2/0 | 23-335-01 #1 |
| 23-309-01 #0 | 23-335-02 #2 |
| 23-309-02 #1 | 23-335-03 #3 |
| 23-309-03 #2 | 23-335-04 #4 |
| 23-309-04 #3 | 23-335-05 #5 |
| 23-309-05 #4 | 23-335-06 #6 |
| 23-309-06 #5 | |
| 23-309-07 #6 | |

OSTEOTOMES



U.S. ARMY PATTERN OSTEOOTOME
6 1/2" (165mm)
23-118-06 6mm wide
23-118-12 12mm wide
23-118-18 18mm wide



LAMBOTTE OSTEOOTOME

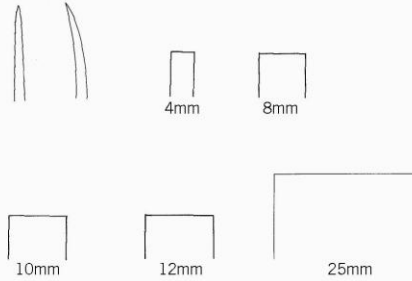

- 5" (127mm) straight without calibration lines
 23-136-04 4mm 23-136-14 14mm
 23-136-06 6mm 23-136-15 15mm
 23-136-08 8mm 23-136-18 18mm
 23-136-10 10mm 23-136-19 19mm
 23-136-12 12mm 23-136-20 20mm
- 7" (178mm) straight with calibration lines
 23-136-54 4mm 23-136-62 12mm
 23-136-55 5mm 23-136-66 16mm
 23-136-56 6mm 23-136-69 19mm
 23-136-58 8mm 23-136-72 22mm
 23-136-60 10mm 23-136-75 25mm
- 9" (229mm) straight without calibration lines
 23-138-06 1/2" (6mm) 23-139-06 1/2" (6mm)
 23-138-13 1/2" (13mm) 23-139-13 1/2" (13mm)
 23-138-19 3/4" (19mm) 23-139-19 3/4" (19mm)
 23-138-25 1" (25mm) 23-139-25 1" (25mm)
 23-138-32 1 1/4" (32mm) 23-139-32 1 1/4" (32mm)
 23-138-38 1 1/2" (38mm) 23-139-38 1 1/2" (38mm)
- 9" (229mm) curved without calibration lines
 23-139-06 1/2" (6mm)
 23-139-13 1/2" (13mm)
 23-139-19 3/4" (19mm)
 23-139-25 1" (25mm)
 23-139-32 1 1/4" (32mm)
 23-139-38 1 1/2" (38mm)

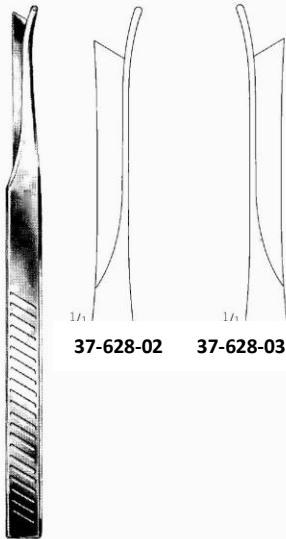

SILVER OSTEOOTOME
7" (178mm) single guard
37-628-01 straight
37-628-02 guard, right
37-628-03 guard, left

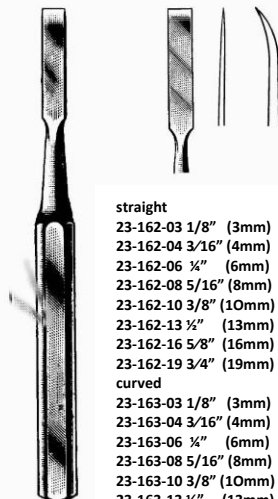

HOKE OSTEOOTOME
5 1/2" (133mm) straight



SHEEHAN OSTEOOTOME 6 1/4" (159mm)

37-626-02 2mm
 37-626-04 4mm
 37-626-06 6mm
 37-626-08 8mm
 37-626-10 10mm
 37-626-12 12mm
 37-626-15 15mm

BONE RASPS AND FILES

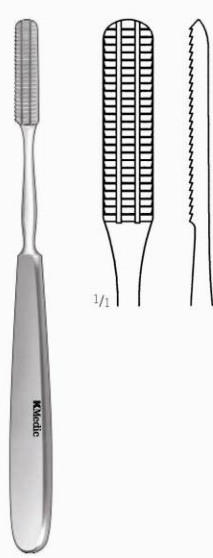

MALTZ RASP
 37-654-18
 7 ¼" (184mm)
 backward cutting

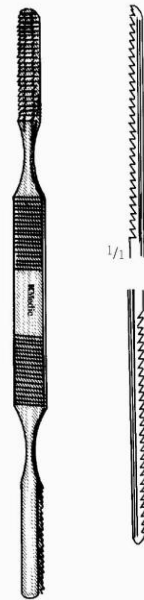

MALTZ RASP IMPROVED
 37-660-20 8 ¼" (210mm) double ended
 forward and backward cutting

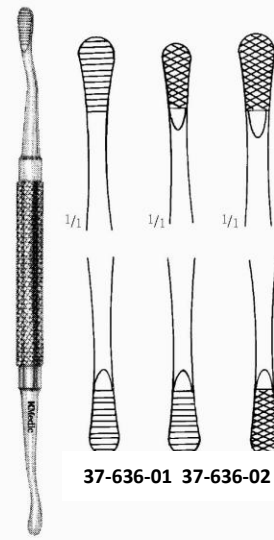

BONE FILES 7" (178mm) double ended
 37-636-01 #12 plain serrations
 37-636-02 #12A plain and cross serrations
 37-636-03 #12CA cross serrations

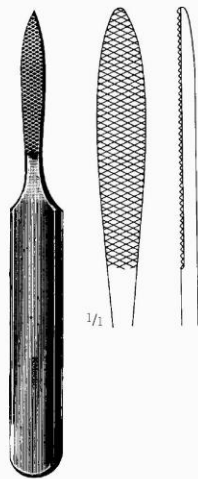

JOSEPH RASP
 37-658-02
 6 ¼" (159mm) fine
 cross serrations

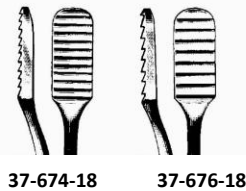

LEWIS RASP backward cutting
 37-674-18 7 ½" (191mm) fine teeth
 37-676-18 7 ½" (191mm) coarse teeth

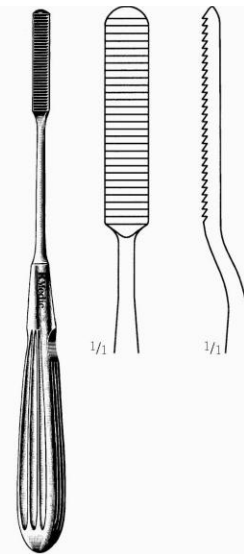

COTTLE RASP
 37-620-21
 8" (203mm)
 backward cutting

BONE RASPS, FILES AND SAWS

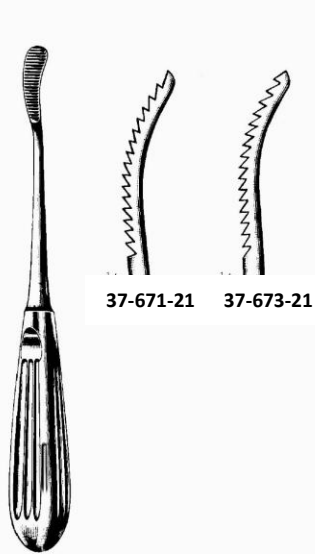

37-671-21 37-673-21

AUFRICHT RASP 8 1/4" (210mm)
 37-671-21 forward cutting
 37-673-21 backward cutting



BONE FILE
 37-640-23
 9 1/2" (241mm) bayonet shank
 half round blade fine teeth

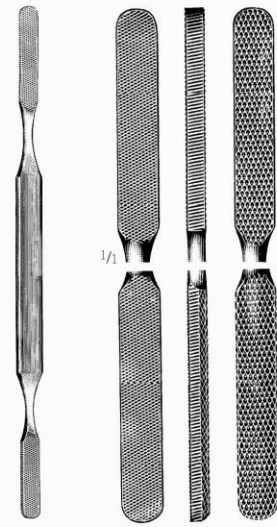

FOMON RASP
 37-680-01
 8 1/2" (216mm) double ended
 fine and coarse teeth
 4-sided, convex and flat



PUTTI BONE RASP
 23-183-27
 11" (279mm) flat ends
 one end curved up
 one end curved sideways



PUTTI BONE RASP
 23-181-30
 12" (305mm) one round end
 and one half round end

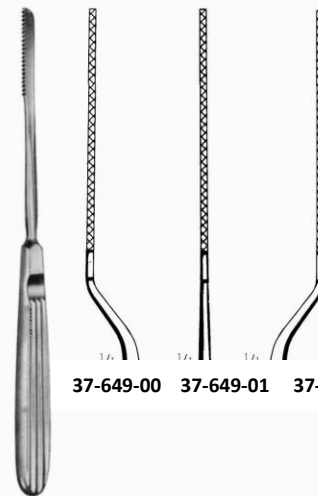

37-649-00 37-649-01 37-649-02

JOSEPH BONE SAW 7 1/2" (191mm)
 37-649-00 straight
 37-649-01 bayonet left
 37-649-02 bayonet right

DERMAL INSTRUMENTS



SCHAMBERG COMEDONE EXTRACTOR
28-879-20
3 ¾" (95mm)
standard
crimped loops

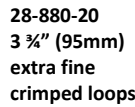

SCHAMBERG COMEDONE EXTRACTOR
28-880-20
3 ¾" (95mm)
square loops

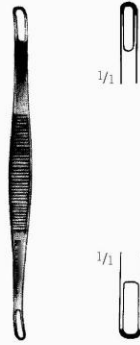

UNNA COMEDONE EXTRACTOR
28-261-14
5 ¾" (146mm)
fenestrated spoon ends

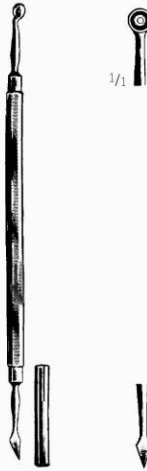

KATSCH COMEDONE EXTRACTOR
28-294-14
6 ¼" (159mm) one fenestrated cup
and curved lancet with cap



GREG COMEDONE EXTRACTOR
28-296-11
5" (127mm) one fenestrated cup
and lancet blade with cap



SAALFELD COMEDONE EXTRACTOR
28-271-10
4 ½" (114mm) with lancet
and one fenestrated cup

DERMAL INSTRUMENTS



KEYES PUNCH 4" (102mm)
 28-240-02 2mm 28-240-05 5mm
 28-240-03 3mm 28-240-06 6mm
 28-240-04 4mm 28-240-08 8mm



FOX CURETTE 5 1/2" (140mm) round
 28-188-01 1mm 28-188-04 4mm
 28-188-02 2mm 28-188-05 5mm
 28-188-03 3mm 28-188-06 6mm

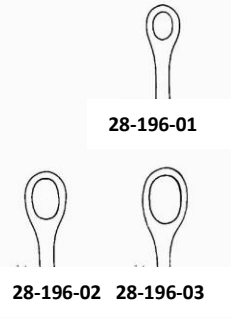

PIFFARD CURETTE 5 1/2" (140mm) oval
 28-196-01 #1 small
 28-196-02 #2 medium
 28-196-03 #3 large

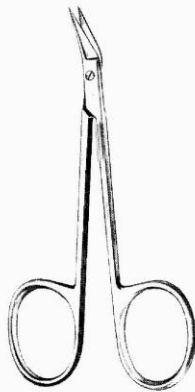

BIRO DERMAL NAEVUS SCISSORS
 54-378-12
 4" (102mm) angled on flat
 sharp outside edges



NAIL SPLITTER

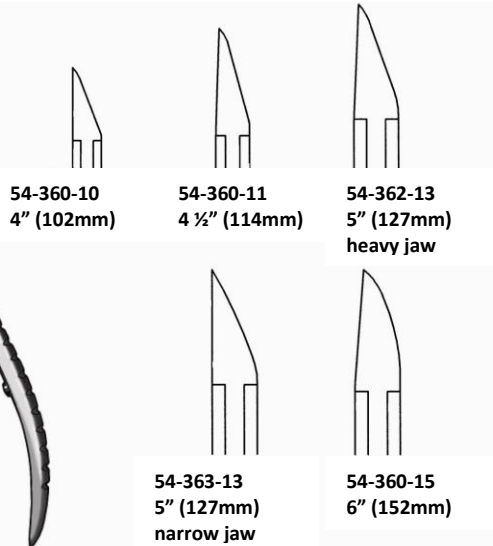

Note: For a sure grip, our splitters have grooved handles.

DERMAL INSTRUMENTS

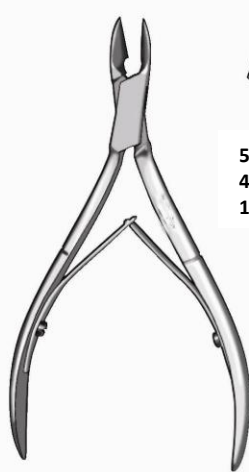

TISSUE NIPPER



54-365-11
4 1/2" (114mm),
11mm cutting edge



54-365-13
5" (127mm)
14mm cutting edge



NAIL NIPPER heavy



54-336-14
5 1/2" (140mm)
concave



54-337-14
5 1/2" (140mm)
straight



NAIL NIPPER
54-341-11
4 1/2" (114mm) concave
chrome
barrel spring



INGROWN NAIL FORCEPS
54-368-13
5" (127mm)
14mm
narrow blade

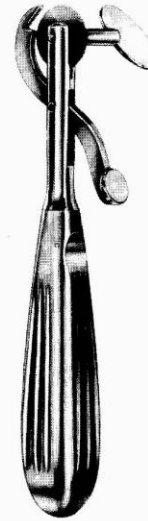

FINGER RING CUTTER
23-972-16
6 1/2" (165mm) chrome
with saw blade

23-972-00
saw blade only

EYE INSTRUMENTS

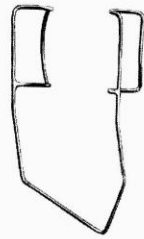

BARRAQUER EYE SPECULUM
1 3/4" (44mm)
34-110-03 small blades 10mm wide
34-110-04 large blades 15mm wide



GRAEFE EYE SPECULUM
34-220-09
3 1/2" (89mm)

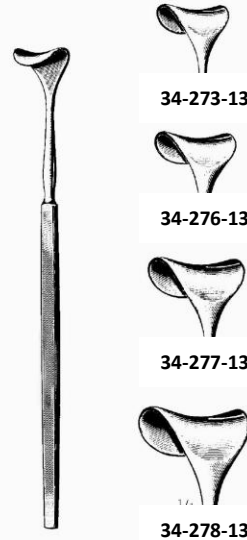

DESMARRES LID RETRACTOR
5 1/2" (140mm)
34-273-13 #1 11mm
34-276-13 #2 13mm
34-277-13 #3 15mm
34-278-13 #4 17mm

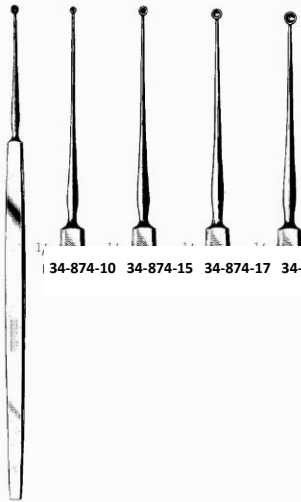

MEYHOEFFER CURETTE 5" (127mm)
34-874-10 #2/0 1.0mm
34-874-15 #0 1.5mm
34-874-17 #1 1.7mm
34-874-20 #2 2.0mm

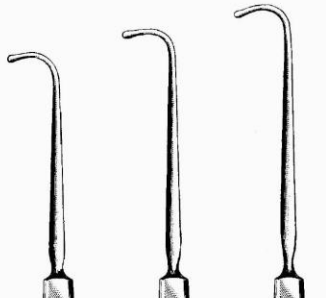

GRAEFE STRABISMUS HOOK
5 1/2" 140mm
34-759-13 small
34-759-14 medium
34-759-15 large



34-226-00 size 0000/000
34-226-01 size 00/0
34-226-12 size 1/2
34-226-34 size 3/4
34-226-56 size 5/6
34-226-78 size 7/8

BOWMAN LACRIMAL PROBES
5" (127mm) sterling

EYE INSTRUMENTS

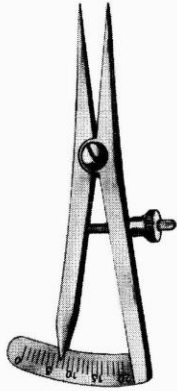

CASTROVIEJO CALIPER
35-133-06
3 1/4" (83mm) graduated
0-15mm

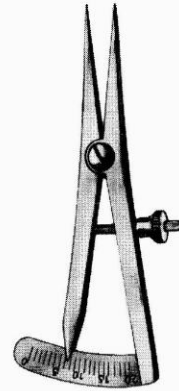

CASTROVIEJO CALIPER
35-133-07
3 1/4" (83mm) graduated
0-20mm



DIX SPUD AND NEEDLE
34-378-20
in reversible screw handle



FOREIGN BODY NEEDLES AND SPUDS



NEEDLE
34-370-01
5" (127mm)
2 x 5mm blade



DAVIS
34-372-01
4 3/4" (121mm)
0.8mm blade



ELLIS
34-374-01
4 1/2" (114mm) curved
1.2mm blade

EYE INSTRUMENTS



BISHOP HARMAN FORCEPS 3 3/8" (86mm)
 35-422-08 extra delicate serrated 0.7mm
 35-426-08 delicate serrated 1.0mm
 35-424-08 delicate 1x2 teeth 1.0mm



TROUTMAN-BARRAQUER FORCEPS
 35-440-07
 3" (76mm) 1x2 teeth
 0.12mm with tying platform

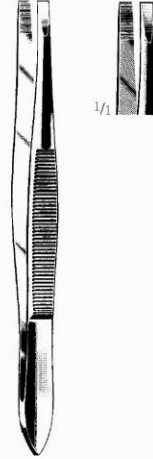

DOUGLAS CILIA FORCEPS
 12-674-09
 3 1/2" (89mm) fine serrations

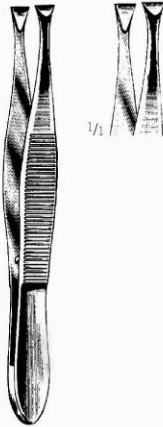

LITTAUER CILIA FORCEPS
 12-664-08
 3 1/2" (89mm) fine serrations



BERGH CILIA FORCEPS
 12-666-09
 3 1/2" (89mm) fine serrations

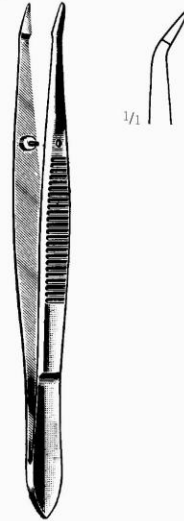

BARRAQUER CILIA & SUTURE FORCEPS
 12-695-10
 4 1/2" (114mm) smooth platform

EAR AND NOSE INSTRUMENTS

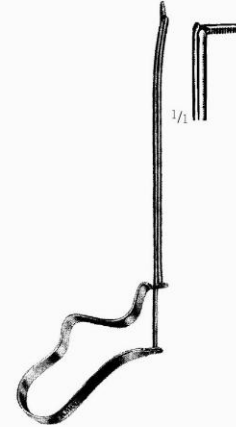
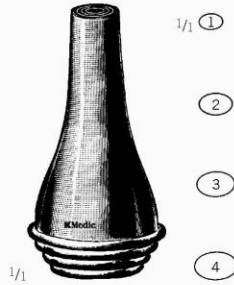
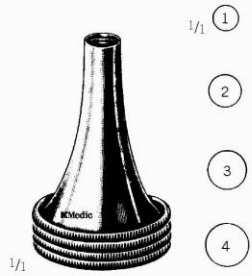

HARTMAN EAR SPECULA round chrom
36-112-11 #1 4mm diameter
36-112-12 #2 5mm diameter
36-112-13 #3 6mm diameter
36-112-14 #4 7mm diameter

GRUBER EAR SPECULA oval adult chrome
36-120-01 #1 4 x 5mm
36-120-02 #2 5 x 6mm
36-120-03 #3 6 x 7mm
36-120-04 #4 7 x 8mm

QUIRE MECHANICAL FINGER
36-418-10
4" (102mm)

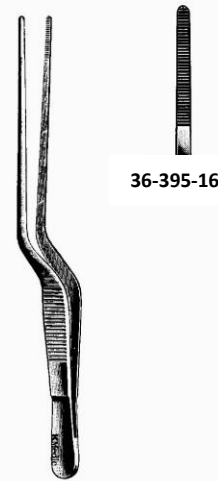

WILDE EAR FORCEPS
36-371-11 4 1/2" (114mm) delicate serrated angular
36-381-13 5" (127mm) serrated angular

LUCAE EAR FORCEPS
36-391-14 5 1/2" (140mm) serrated bayonet

JANSEN (GRUENWALD) EAR FORCEPS
36-395-16 6 1/4" (159mm) serrated bayonet
36-395-20 8" (203mm) serrated bayonet

EAR AND NOSE INSTRUMENTS



VIENNA SPECULUM LIGHT
 36-858-14
 5 3/4" (146mm)
 adult



VIENNA SPECULUM 5 3/4" (146mm)

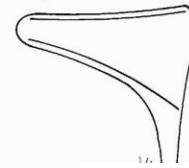

36-843-02
 medium

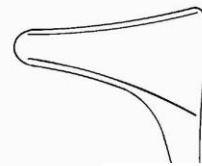

36-843-03
 large



HALLE-TIECK SPECULUM
 36-852-13 36-853-14
 5 1/2" (140mm) 5 1/2" (140mm)
 infant adult



36-852-13



KILLIAN NASAL SPECULUM 6" (152mm)
 36-856-02 2" blade
 36-856-03 3" blade
 36-856-04 3 1/2" blade



AUFRICHT NASAL RETRACTOR
 37-697-19
 6 1/2" (165mm)
 solid blade

EAR AND NOSE INSTRUMENTS

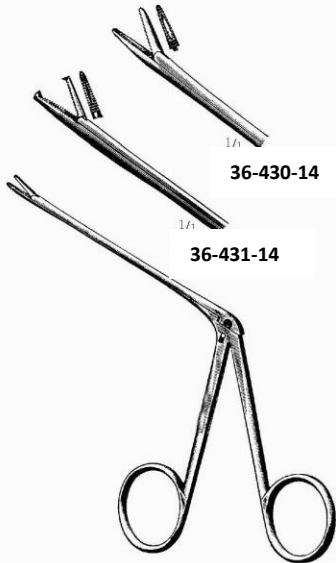

HARTMANN ALLIGATOR FORCEPS
 36-430-08 3 1/2" (89mm) serrated
 36-430-14 5 1/2" (140mm) serrated
 36-430-16 6 1/2" (165mm) serrated
 36-431-08 3 1/2" (89mm) 1x2 teeth serrated

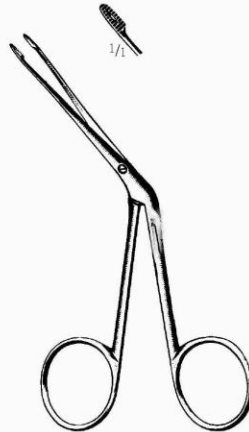

HARTMANN EAR DRESSING FORCEPS
 36-407-14
 5" (127mm) delicate
 serrated

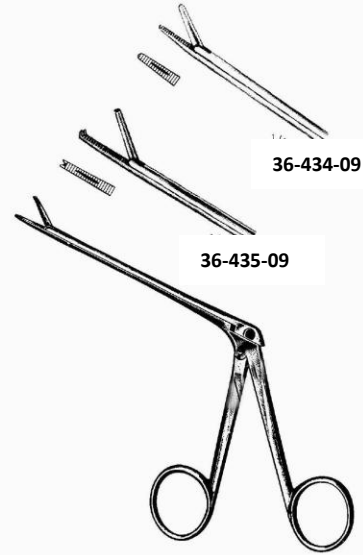

NOYES ALLIGATOR FORCEPS
 36-434-09 36-435-09
 5 1/2" (140mm) 5 1/2" (140mm)
 serrated 1x2 teeth
 serrated

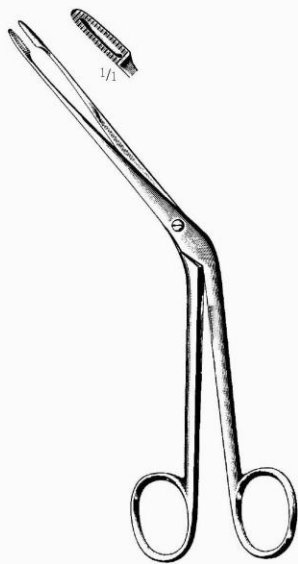

HARTMANN NASAL FORCEPS
 37-143-20
 8" (203mm) standard serrated

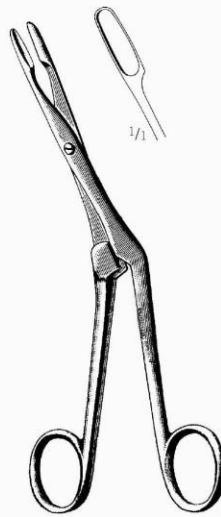

KNIGHT SEPTUM FORCEPS
 37-207-18
 7" (178mm)
 cup jaws



LUC SEPTUM FORCEPS 8" (203mm)
 37-215-01 37-215-02
 small cup large cup

EAR AND NOSE INSTRUMENTS



GROSS SPOON AND HOOK
36-543-12
4 3/4" (121mm)



BILLEAU LOOP 6 1/2" (165mm)

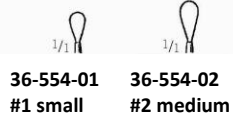

COAKLEY ANTRUM CURETTES
6 3/4" (171mm)

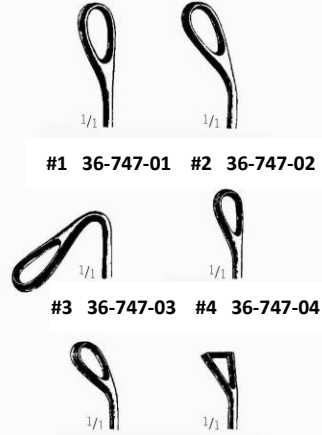

BUCK CURETTE 6 1/2" (165mm)



- straight blunt
- 36-495-02 #00
- 36-495-10 #0
- 36-495-11 #1
- 36-495-12 #2
- 36-495-13 #3
- angled blunt
- 36-497-02 #00
- 36-497-10 #0
- 36-497-11 #1
- 36-497-12 #2
- 36-497-13 #3
- straight sharp
- 36-496-02 #00
- 36-496-10 #0
- 36-496-11 #1
- 36-496-12 #2
- 36-496-13 #3
- angled sharp
- 36-498-02 #00
- 36-498-10 #0
- 36-498-11 #1
- 36-498-12 #2
- 36-498-13 #3

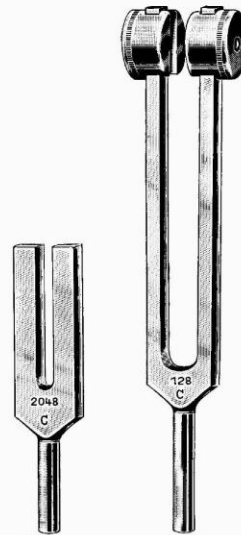

TUNING FORK aluminum alloy
36-189-10 C-128
36-192-11 C-256
36-194-12 C-512
36-196-13 C-1024
36-198-14 C-2048
36-200-00 set of five in a case

MALLETS



MALLET #49
23-215-19
7 ¾" (195mm) lead filled and faced
weight: 7 oz. (200 grams)
head weight: 5 oz. (150 grams)
head diameter: 22mm



*Autoclavable to
250°F (121°C).*

MEAD MALLET
23-220-17
7 ½" (191mm) with replaceable nylon caps
weight: 11 oz. (315 grams)
head weight: 6 oz. (170 grams)
head diameter: 20mm

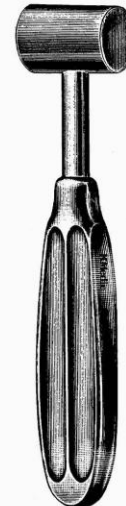

GERZOG BONE MALLET
23-224-18
7 ½" (191mm) lead filled and faced
weight: 10 oz. (285 grams)
head weight: 7 oz. (200 grams)
head diameter: 25mm



LUCAE BONE MALLET
23-200-01
8" (203mm) brass head
stainless steel handle
weight: 9 oz. (260 grams)
head weight: 5 oz. (150 grams)
head diameter: 25mm



*Autoclavable to
250°F (121°C).*

MALLET lightweight
23-240-09
7 ½" (191mm) with two replaceable nylon caps
anodized aluminum handle
weight: 7 oz. (200 grams)
head weight: 4 oz. (120 grams)
head diameter: 25mm



HEATH MALLET heavyweight
23-215-19
7 ½" (191mm) solid stainless steel
weight: 2 lbs. (900 grams)
head weight: 1 lb. 4 oz. (570 grams)
head diameter: 40mm

BONE CUTTING INSTRUMENTS

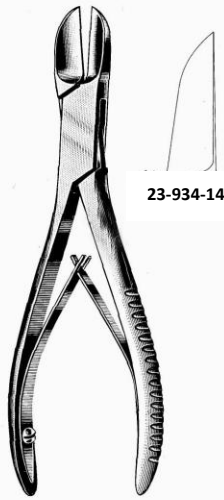

23-934-14

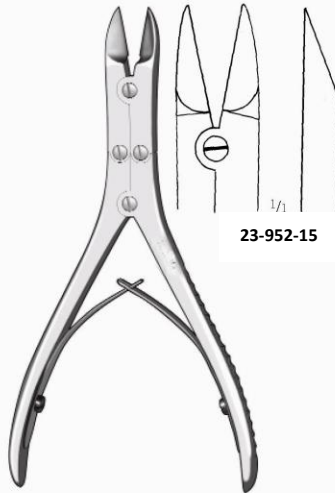

23-952-15

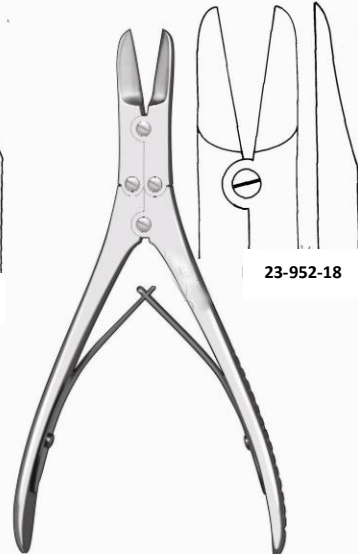

23-952-18

LISTON BONE FORCEPS
straight
23-934-14 5 1/2"
23-934-17 6 3/4"
23-934-19 7 1/2"
angled on flat
23-935-14 5 1/2" 140mm
23-935-17 6 3/4" (171mm)
23-935-19 7 1/2" (191mm)

RUSKIN-LISTON FORCEPS 6" (152mm)
23-950-15 straight
23-952-15 straight delicate
23-951-15 curved delicate

RUSKIN-LISTON FORCEPS 7 1/2" (191mm)
23-950-18 straight
23-952-18 straight delicate
23-951-18 angled on flat

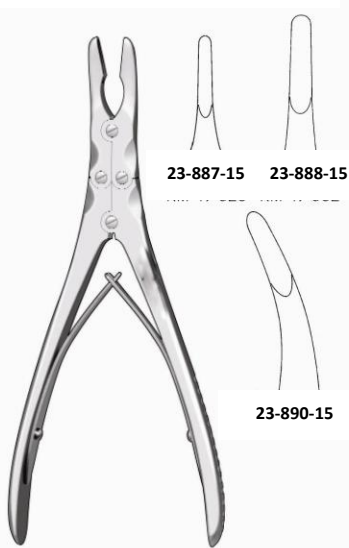

23-890-15

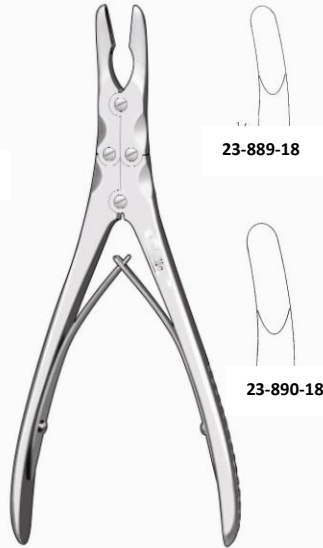

23-890-18

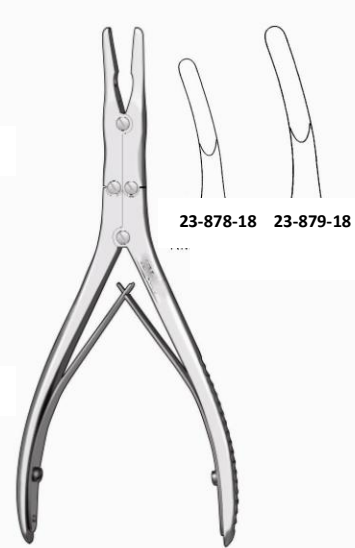

23-878-18 23-879-18

RUSKIN RONGEUR 6" (152mm)
straight
23-887-15 2x14mm bite delicate
23-888-15 3x15mm bite
curved
23-890-15 3x15mm bite

RUSKIN RONGEUR 7 1/4" (184mm)
straight
23-887-18 4x16mm bite
23-888-18 6x16mm bite
curved
23-889-18 4x16mm bite
23-890-18 6x16mm bite

BEYER RONGEUR 7" (178mm)
curved
23-878-18 3x14mm bite
23-879-18 4x15mm bite

ORTHOPEDIC INSTRUMENTS

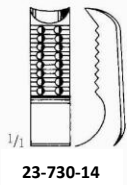

KERN BONE FORCEPS

23-730-14
 5 3/4" (146mm)
 with ratchet

23-730-21
 8 1/2" (216mm)
 with ratchet

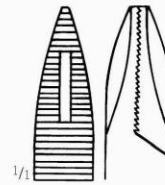

NEEDLE NOSE PLIERS

22-514-14
 5 1/2" (140mm)
 for wire manipulation

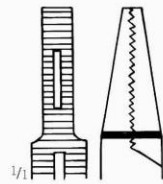

FLAT NOSE PLIERS
 22-515-14
 5 1/2" (140mm)
 for wire manipulation

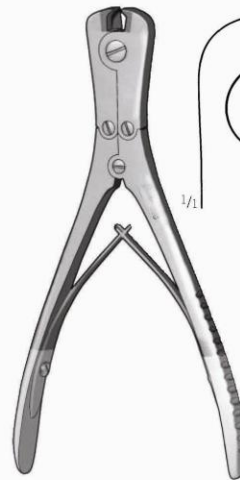
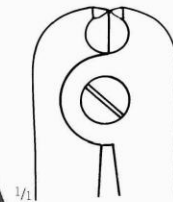

WIRE CUTTER
 22-526-18
 7" (178mm) front and side cutting
 with carbide inserts, double action
 maximum capacity .062 (1.6mm)

WIRE AND PIN CUTTERS

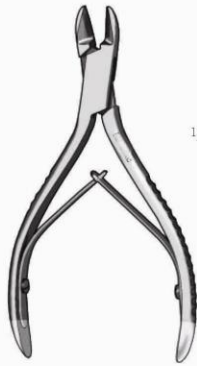

PEDIATRIC WIRE CUTTER
 22-517-12
 4 3/4" (121mm) carbide inserts
 cuts up to .028" (0.7mm)

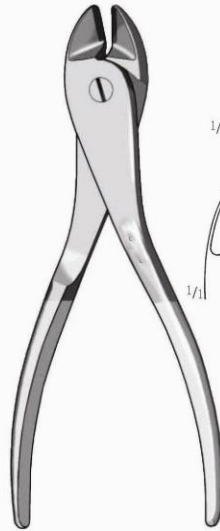

SIDE BITE WIRE CUTTER
 22-523-18
 7" (178mm) welded carbide jaws
 cuts up to .062" (1.6mm)

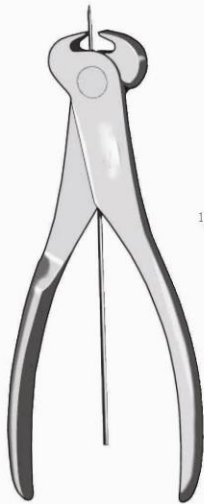
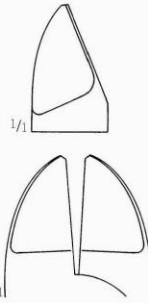

CANNULATED PIN CUTTER
 22-520-18
 7 1/2" (191mm)
 cuts up to .062" (1.6mm)

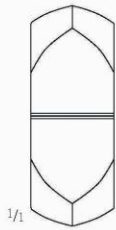

DOUBLE ACTION WIRE CUTTER
 23-523-22
 8 1/2" (216mm) angled
 carbide inserts
 cuts up to 3/32" (2.4mm)

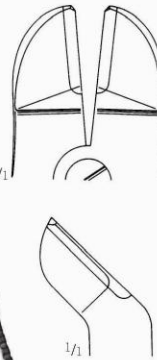

PIN CUTTER (LARGE)
 22-528-00
 22" (559mm) side cutting
 cuts up to 1/4" (6.3mm)

PLASTER CAST INSTRUMENTS

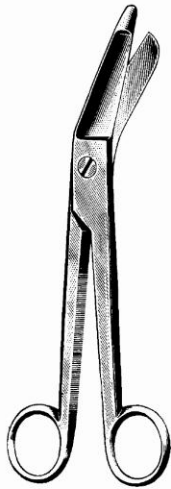

ESMARCH SHEARS
21-205-20
8" (203mm)

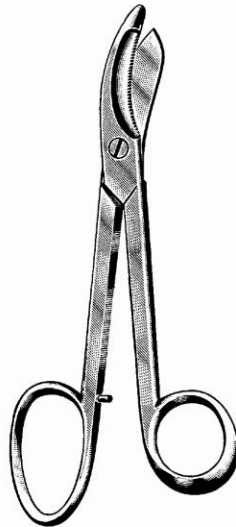

BRUNS SHEARS
21-223-24
9 1/4" (235mm)
one serrated blade

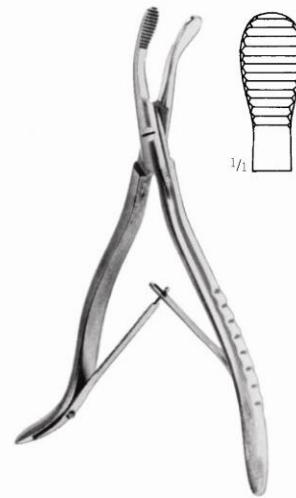

PEDIATRIC CAST BREAKER
21-535-17
7" (178mm)

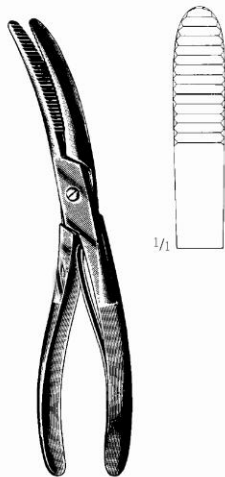

PLASTER EDGER WOLFF
21-541-18 21-541-24
7" (178mm) 9 1/2" (241mm)
small

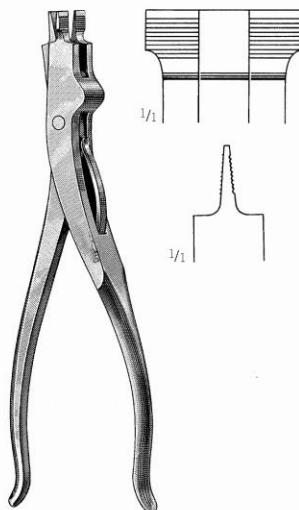

PRIMAX CAST SPREADER
21-522-23
9" (229mm) serrated
3 prongs



HENNIG PLASTER SPREADER
21-520-28
11" (279mm)

GYNECOLOGICAL AND OBSTETRICAL INSTRUMENTS



PEDERSON SPECULUM
32-128-01 small
32-128-02 medium
32-128-03 large



SLENDER PEDERSON SPECULUM
32-129-01
narrow blades



GRAVES SPECULUM
32-130-01 small
32-130-02 medium
32-130-03 large

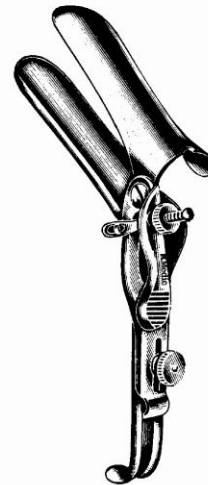

GRAVES OPEN SIDE SPECULUM
32-131-02
medium size
wide angle blades

GYNECOLOGICAL AND OBSTETRICAL INSTRUMENTS

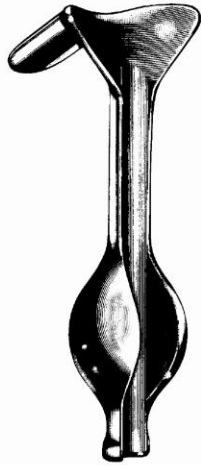

AUVARD VAGINAL SPECULA 9" (229mm)
32-310-22 1 1/2" x 3 3/4", 2 lbs.
(38mm x 83mm, 900 grams)
32-310-23 1 1/2" x 3 3/4", 2 1/2 lbs.
(38mm x 83mm, 1,134 grams)
32-310-24 1 1/2" x 3 3/4" 3 lbs.
(38mm x 83mm, 1,361 grams)
32-310-25 1 3/8" x 4" acute angle, 2 1/2 lbs.
(35mm x 102mm, 1,134 grams)

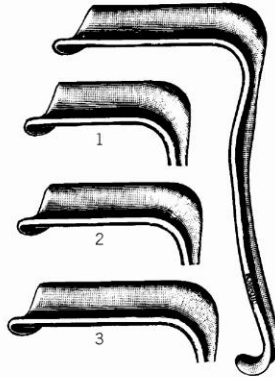

EASTMAN VAGINAL RETRACTOR 7" (178mm)
32-170-01 #1 small
32-170-02 #2 medium
32-170-03 #3 large

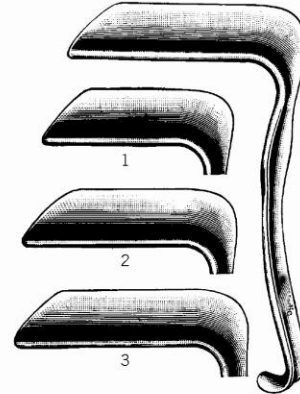

JACKSON VAGINAL RETRACTOR 7" (178mm)
32-165-01 #1 small
32-165-02 #2 medium
32-165-03 #3 large

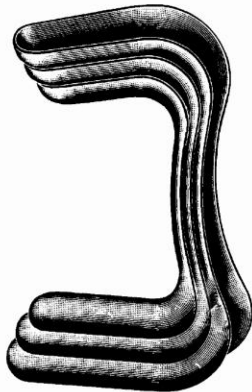

SIMS VAGINAL RETRACTOR double ended
32-160-01 #1 small
32-160-02 #2 medium
32-160-03 #3 large

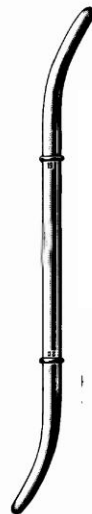

HANK UTERINE DILATORS 11" (279mm)
double ended



HEGAR UTERINE DILATORS 8" (203mm)
double ended

32-460-10 size 9 & 10
32-460-12 size 11 & 12
32-460-14 size 13 & 14
32-460-16 size 15 & 16
32-460-18 size 17 & 18
32-460-20 size 19 & 20
32-460-00 set of six in a case

32-430-04 size 3mm & 4mm
32-430-06 size 5mm & 6mm
32-430-08 size 7mm & 8mm
32-430-10 size 9mm & 10mm
32-430-12 size 11mm & 12mm
32-430-14 size 13mm & 14mm
32-430-16 size 15mm & 16mm
32-430-18 size 17mm & 18mm
32-430-00 set of eight in a case

GYNECOLOGICAL AND OBSTETRICAL INSTRUMENTS



32-440-15 size 13 & 15 french
32-440-19 size 17 & 19 french
32-440-23 size 21 & 23 french
32-440-27 size 25 & 27 french
32-440-31 size 29 & 31 french
32-440-35 size 33 & 35 french
32-440-39 size 37 & 39 french
32-440-43 size 41 & 43 french
32-440-00 set of eight in a case
1 french = .33mm

PRATT UTERINE DILATORS
32-440-00
11 1/2" (292mm)
double ended



SIMS UTERINE SOUND
32-583-32
13" (330mm) cm scale
malleable silver plated



SIMPSON UTERINE SOUND
13" (330mm)
malleable silver plated
32-584-32 inch scale
32-585-32 cm scale

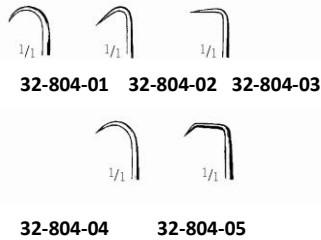

EMMETT UTERINE TENACULUM HOOK
9" (229mm)
32-804-01 #1 narrow curved
32-804-02 #2 acute angle
32-804-03 #3 right angle
32-804-04 #4 wide curved
32-804-05 #5 double angle

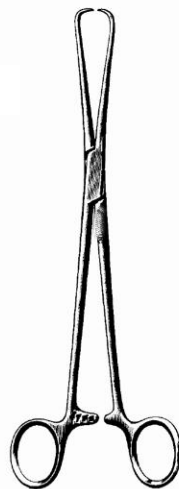



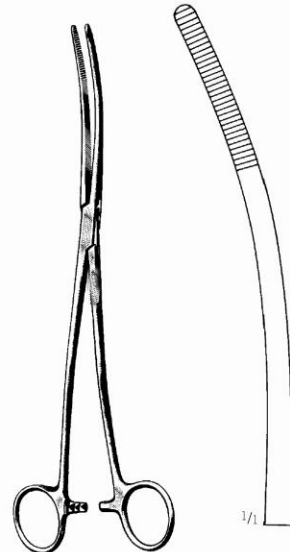



SCHROEDER TENACULUM FORCEPS
32-622-25 32-623-25
9 1/2" (241mm) 9 1/2" (241mm)
S-shape

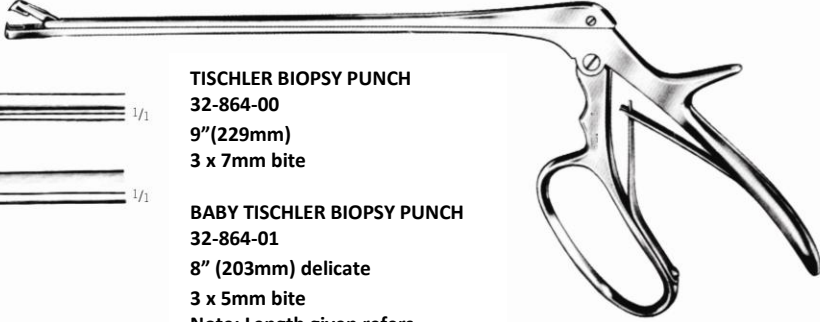

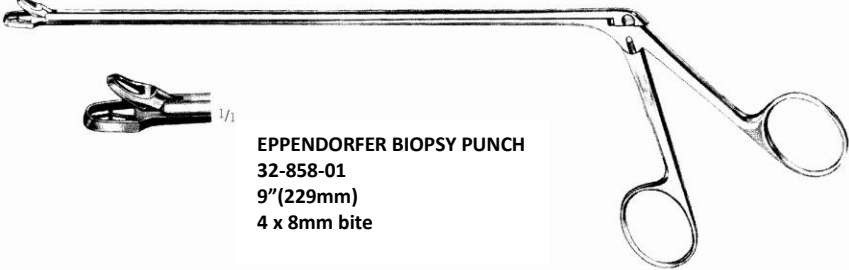
BOZEMANN UTERINE DRESSING FORCEPS
14-313-26 14-314-26
10 1/4" (260mm) 10 1/4" (260mm)
straight curved

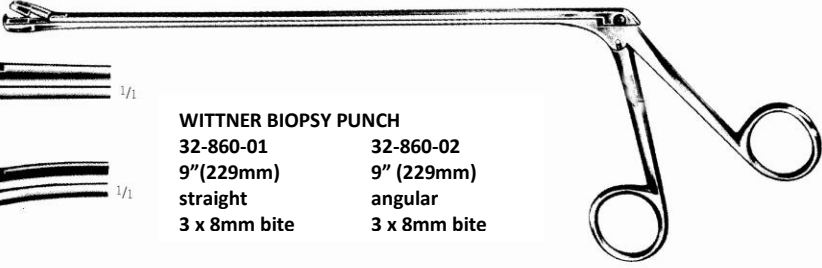
GYNECOLOGICAL AND OBSTETRICAL INSTRUMENTS

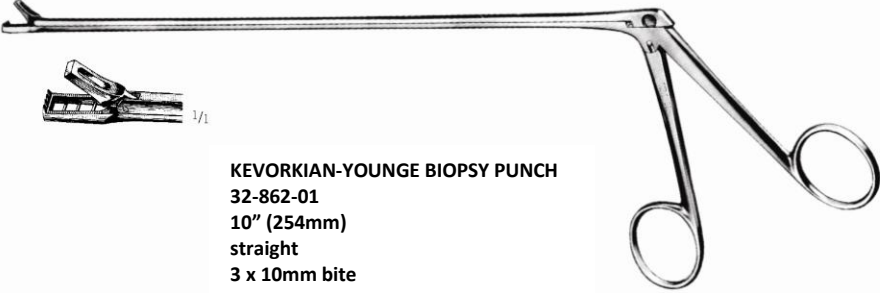
32-864-00		<p>TISCHLER BIOPSY PUNCH 32-864-00 9" (229mm) 3 x 7mm bite</p>									
32-864-01		<p>BABY TISCHLER BIOPSY PUNCH 32-864-01 8" (203mm) delicate 3 x 5mm bite Note: Length given refers to working length.</p>									
		<p>EPPENDORFER BIOPSY PUNCH 32-858-01 9" (229mm) 4 x 8mm bite</p>									
32-860-01		<p>WITTNER BIOPSY PUNCH</p>									
32-860-02		<table border="0"> <tr> <td data-bbox="638 1136 743 1163">32-860-01</td> <td data-bbox="829 1136 935 1163">32-860-02</td> </tr> <tr> <td data-bbox="638 1163 743 1190">9" (229mm)</td> <td data-bbox="829 1163 935 1190">9" (229mm)</td> </tr> <tr> <td data-bbox="638 1190 743 1218">straight</td> <td data-bbox="829 1190 935 1218">angular</td> </tr> <tr> <td data-bbox="638 1218 743 1245">3 x 8mm bite</td> <td data-bbox="829 1218 935 1245">3 x 8mm bite</td> </tr> </table>	32-860-01	32-860-02	9" (229mm)	9" (229mm)	straight	angular	3 x 8mm bite	3 x 8mm bite	
32-860-01	32-860-02										
9" (229mm)	9" (229mm)										
straight	angular										
3 x 8mm bite	3 x 8mm bite										
		<p>KEVORKIAN-YOUNG BIOPSY PUNCH 32-862-01 10" (254mm) straight 3 x 10mm bite</p>									

GYNECOLOGICAL AND OBSTETRICAL INSTRUMENTS

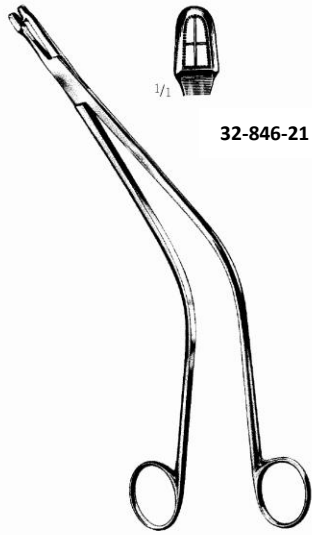

32-846-21

SCHUBERT BIOPSY PUNCH
32-846-21 32-846-28
8 ½" (216mm) 10 ½" (267mm)
straight angular
4 x 8mm bite 4 x 8mm bite

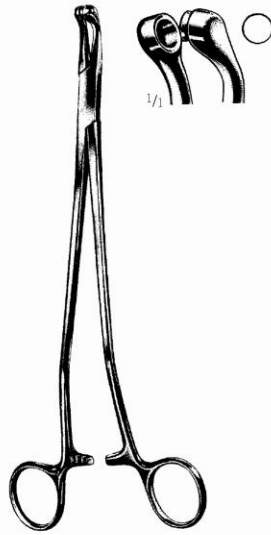

THOMS-GAYLOR BIOPSY PUNCH
32-581-22
9 ½" (241mm) interfitted jaw
5mm cup



32-827-30 32-828-30

**KEVORKIAN-YOUNGE
ENDOCERVICAL BIOPSY
CURETTE 12" (305mm)**
32-827-30
without basket
3 x 12mm sharp tip

32-828-30
with basket
3 x 12mm sharp tip



HEANEY UTERINE BIOPSY CURETTE
32-820-01
9" (229mm)
serrated

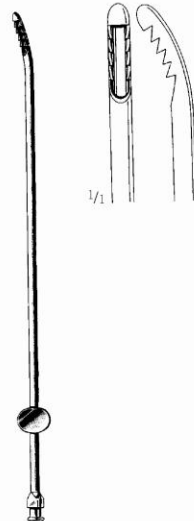

NOVAK SUCTION BIOPSY CURETTE
32-827-30 32-828-30
9 ½" (241mm) 9 ½" (241mm)
2mm diameter 4mm diameter

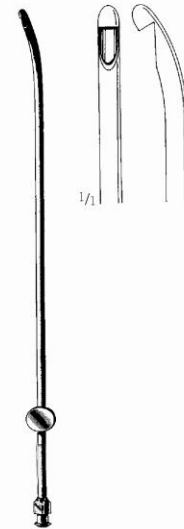

RANDALL SUCTION BIOPSY CURETTE
32-822-01
9 ¾" (248mm)
4mm diameter

GYNECOLOGICAL AND OBSTETRICAL INSTRUMENTS

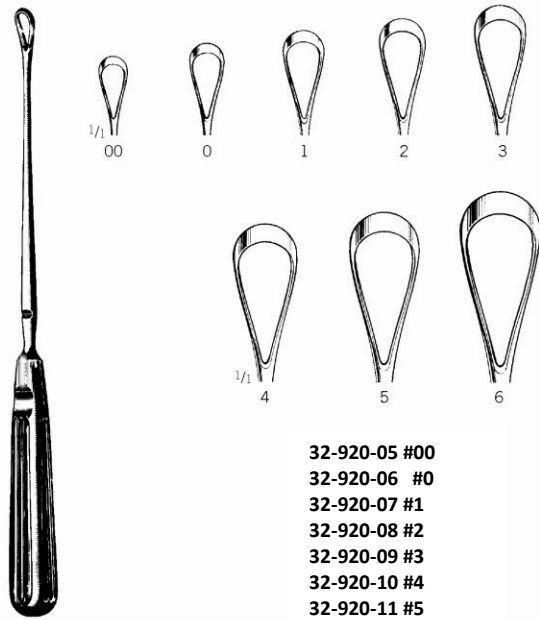

- 32-920-05 #00
- 32-920-06 #0
- 32-920-07 #1
- 32-920-08 #2
- 32-920-09 #3
- 32-920-10 #4
- 32-920-11 #5
- 32-920-12 #6

SIMS UTERINE CURETTE 11" (279mm) malleable sharp



**KOGAN ENDOCERVICAL SPECULUM
32-383-24
9 1/2" (241mm) with gauge and
set screw 7 x 25mm jaws**



BRAUN EPISIOTOMY SCISSORS
11-535-14 11-537-22
5 1/2" (140mm) 8 1/2" (216mm)
angled sideways angled sideways



UMBILICAL SCISSORS
11-545-10
4 1/4" (108mm)

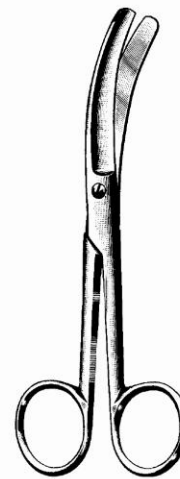

BUSCH UMBILICAL SCISSORS
11-551-16
6 1/2" (165mm)
curved sideways

GYNECOLOGICAL AND OBSTETRICAL INSTRUMENTS



DE LEE OBSTETRICAL FORCEPS
fenestrated blades
33-142-30 33-142-35
12" (305mm) 14" (356mm)
short model long model

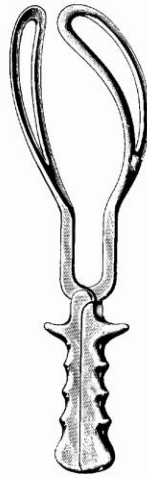

SIMPSON OBSTETRICAL FORCEPS
fenestrated blades
33-145-30 33-149-36
12" (305mm) 14" (356mm)
short model long model

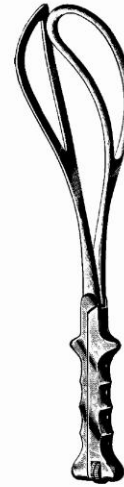

ELLIOT OBSTETRICAL FORCEPS fenestrated blades
33-148-30 33-148-35
12 ½" (317mm) 15" (381mm)
short model long model

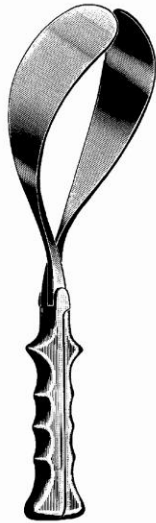

MCLEAN OBSTETRICAL FORCEPS
33-194-35
14" (356mm) solid blades, short shanks

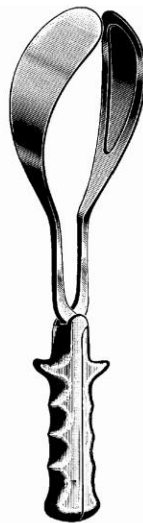

SIMPSON-LUIKART OBSTETRICAL FORCEPS
33-196-40
14" (356mm) solid blades



KIELLAND-LUIKART OBSTETRICAL FORCEPS
33-198-44
15 ½" (394mm) solid blades

RECTAL INSTRUMENTS

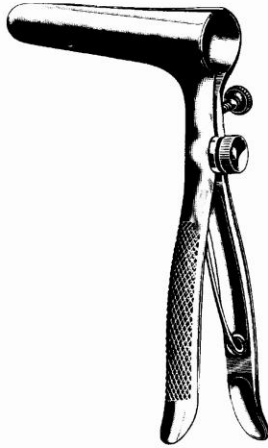

BODENHAMMER RECTAL SPECULUM
 30-613-15
 6" (152mm) long with set screw
 3 1/2" x 3/4" (89mm x 19mm)
 solid blades



SIMS RECTAL SPECULUM
 30-615-15
 6" (152mm) long with set screw
 3 1/2" x 5/8" (89mm x 16mm)
 fenestrated blades

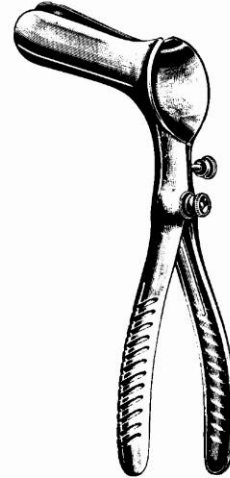

PRATT RECTAL SPECULUM
 KM 63-312
 8 1/2" (216mm) long with set screw
 3 1/2" x 1" (89mm x 25mm)
 solid blades



FANSLER-IVES RECTAL SPECULUM
 30-641-15 30-641-00
 chrome with obturator obturator only
 3 1/4" long x 1 1/8"
 (82mm x 29mm)
 outside diameter



HIRSCHMAN RECTAL ANOSCOPE
 30-642-01 small, 2 1/4" (57mm) long x
 9/16" (14mm) inside diameter
 30-642-02 medium, 2 5/8" (67mm) long x
 11/16" (18mm) inside diameter
 30-642-03 large, 3 1/2" (89mm) long x
 7/8" (22mm) inside diameter

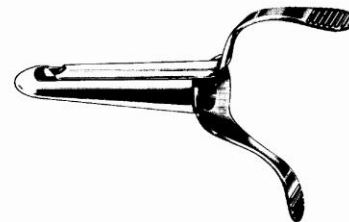

BRINKERHOFF RECTAL SPECULUM
 30-644-01 small, 3 1/2" (89mm) long x
 1" (25mm) tapers to 1/2" (13mm)
 30-644-02 medium, 4" (102mm) long x
 1" (25mm) tapers to 5/8" (16mm)
 30-644-03 large, 4 3/4" (121mm) long x
 1 1/4" (32mm) tapers to 3/4"

RECTAL AND UROLOGICAL INSTRUMENTS

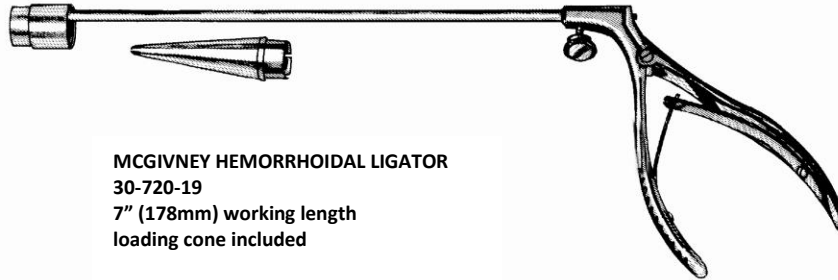

MCGIVNEY HEMORRHOIDAL LIGATOR
30-720-19
7" (178mm) working length
loading cone included

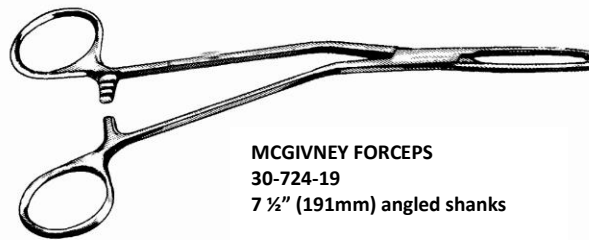

MCGIVNEY FORCEPS
30-724-19
7 1/2" (191mm) angled shanks

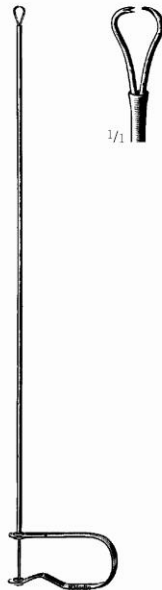

COTTON CARRIER
32-866-28
15" (381mm) shaft
2x3 teeth, spring handle



- 31-597-08 8 french
 - 31-597-10 10 french
 - 31-597-12 12 french
 - 31-597-14 14 french
 - 31-597-16 16 french
 - 31-597-18 18 french
 - 31-597-20 20 french
 - 31-597-22 22 french
 - 31-597-24 24 french
 - 31-597-26 26 french
 - 31-597-28 28 french
 - 31-597-30 30 french
 - 31-597-32 32 french
 - 31-597-34 34 french
- 1 french = .33mm

DITTEL URETHRAL SOUNDS



- 31-599-08 8 french
 - 31-599-10 10 french
 - 31-599-12 12 french
 - 31-599-14 14 french
 - 31-599-16 16 french
 - 31-599-18 18 french
 - 31-599-20 20 french
 - 31-599-22 22 french
 - 31-599-24 24 french
 - 31-599-26 26 french
 - 31-599-28 28 french
 - 31-599-30 30 french
 - 31-599-32 32 french
 - 31-599-34 34 french
- 31-599-00 set of 12 in a case
(sizes 8-30)
1 french = .33mm

VAN BUREN URETHRAL SOUNDS
11" (279mm) curved

CARDIOVASCULAR INSTRUMENTS

VASCULAR FORCEPS

Atrauma

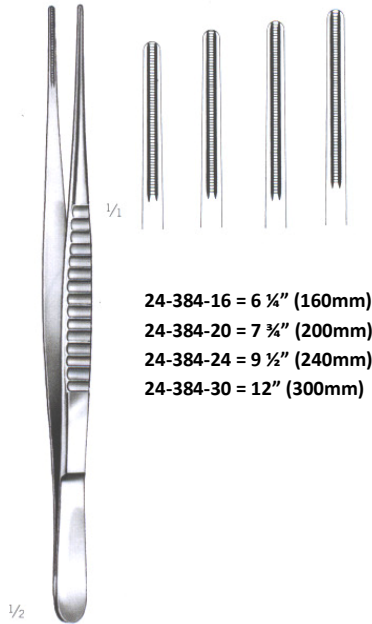

24-384-16 = 6 1/4" (160mm)
 24-384-20 = 7 3/8" (200mm)
 24-384-24 = 9 1/2" (240mm)
 24-384-30 = 12" (300mm)

DE BAKY VASCULAR FORCEPS
 2.7mm

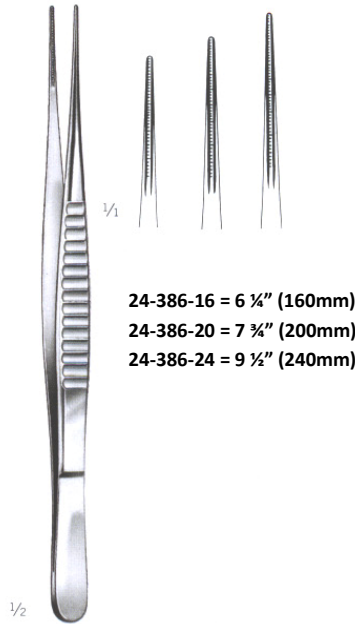

24-386-16 = 6 1/4" (160mm)
 24-386-20 = 7 3/8" (200mm)
 24-386-24 = 9 1/2" (240mm)

DE BAKY VASCULAR FORCEPS
 1.5mm

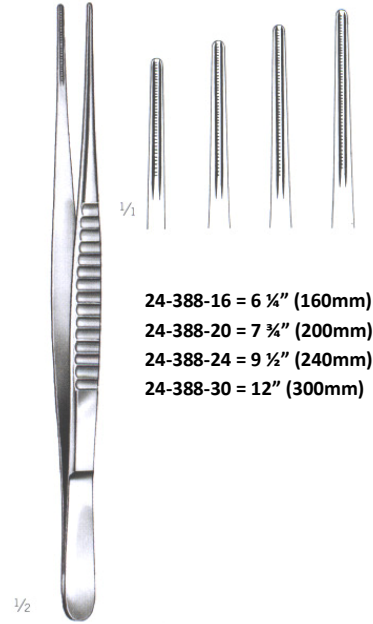

24-388-16 = 6 1/4" (160mm)
 24-388-20 = 7 3/8" (200mm)
 24-388-24 = 9 1/2" (240mm)
 24-388-30 = 12" (300mm)

DE BAKY VASCULAR FORCEPS
 2.0mm

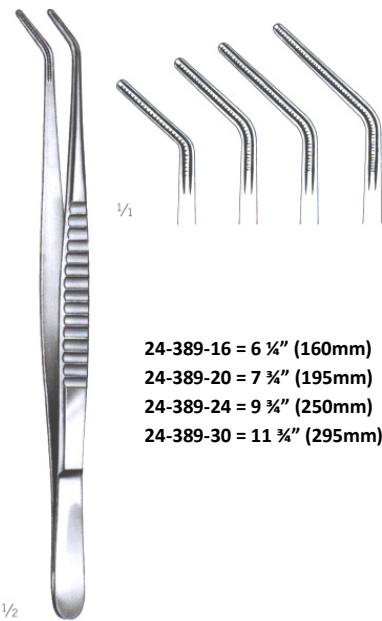

24-389-16 = 6 1/4" (160mm)
 24-389-20 = 7 3/8" (195mm)
 24-389-24 = 9 3/4" (250mm)
 24-389-30 = 11 3/4" (295mm)

DE BAKY VASCULAR FORCEPS
 2.0mm

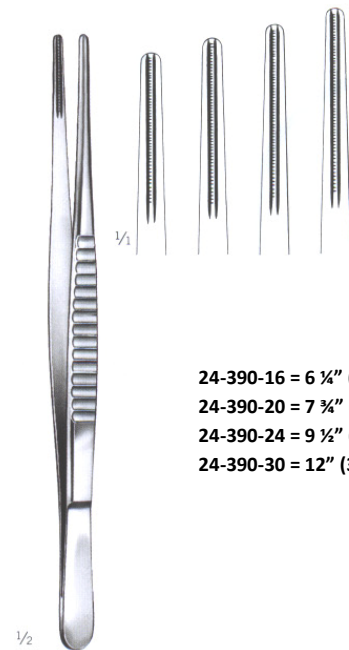

24-390-16 = 6 1/4" (160mm)
 24-390-20 = 7 3/8" (200mm)
 24-390-24 = 9 1/2" (240mm)
 24-390-30 = 12" (300mm)

DE BAKY VASCULAR FORCEPS
 3.5mm

CARDIOVASCULAR INSTRUMENTS

PEDIATRIC VASCULAR CLAMPS

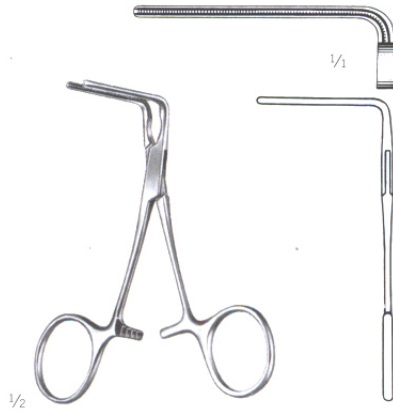

**DE BAKY PEDIATRIC
 VASCULAR CLAMPS**
 24-458-10
 3 1/2" (100mm)



**DE BAKY PEDIATRIC
 VASCULAR CLAMPS**
 24-458-11
 5" (130mm)



**DE BAKY PEDIATRIC
 VASCULAR CLAMPS**
 24-458-12
 5" (130mm)

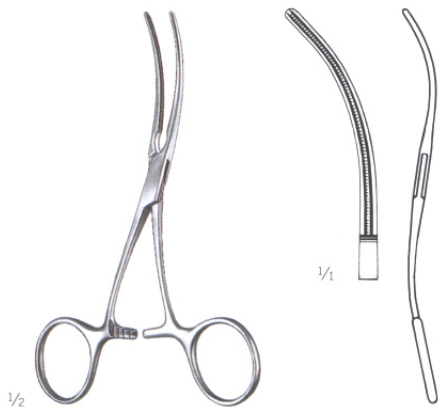

**DE BAKY PEDIATRIC
 VASCULAR CLAMPS**
 24-459-12
 4 3/4" (125mm)

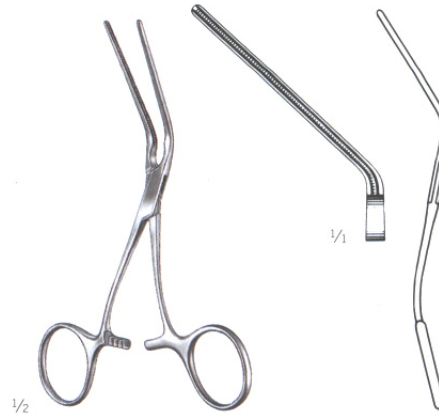

**DE BAKY PEDIATRIC
 VASCULAR CLAMPS**
 24-459-13
 4 3/4" (125mm)

CARDIOVASCULAR INSTRUMENTS

PEDIATRIC VASCULAR CLAMPS

Atrauma

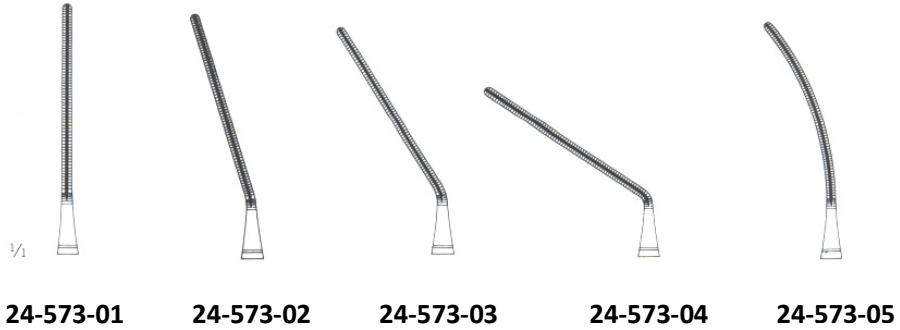

DE BAKY PEDIATRIC VASCULAR CLAMPS 5 1/2" (140mm)

CARDIOVASCULAR INSTRUMENTS

PEDIATRIC VASCULAR CLAMPS

Atrauma



24-593-01



24-593-02



24-593-03



24-595-01



24-595-02



24-595-03



24-597-12



1/2

CASTANEDA PEDIATRIC VASCULAR CLAMPS 4 3/4" (120mm)

CARDIOVASCULAR INSTRUMENTS

PEDIATRIC VASCULAR CLAMPS

Atrauma



1/1

24-426-01
Style # 1



1/1

24-426-02
Style # 2



1/2

HARKEN CLAMPS
9 1/2" (230mm)

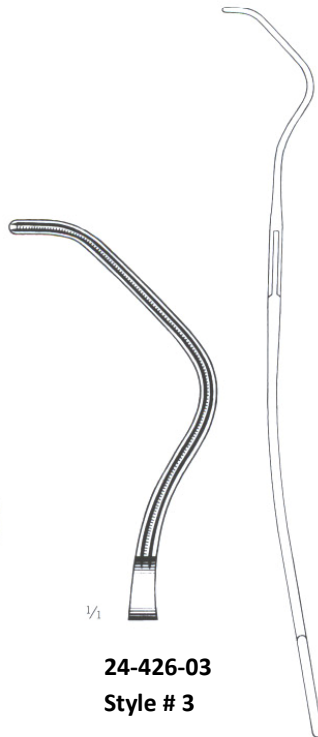

1/1

24-426-03
Style # 3



1/1

24-426-04
Style # 4

CARDIOVASCULAR INSTRUMENTS

THORACIC FORCEPS



RUMEL THORACIC FORCEPS
 9 ½", 24cm



13-461-02
 Slight curve

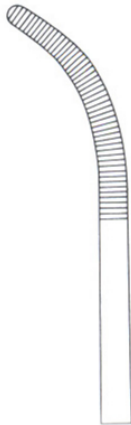

13-461-03
 Medium curve

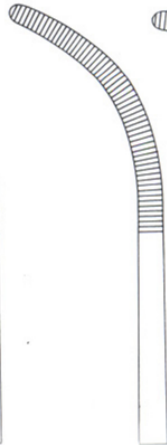

13-461-04
 Full curve



13-461-05
 Angular

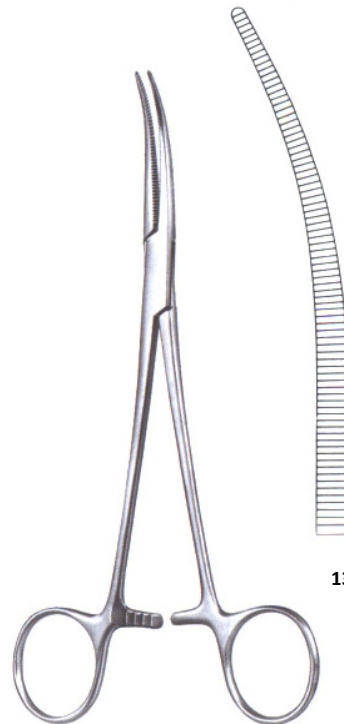

13-439-24

SAROT (CRAFOORD) THORACIC FORCEPS 25cm 9 ½"

CARDIOVASCULAR INSTRUMENTS

BULLDOG CLAMPS

Atrauma



24-398-06
 2 1/2" (63mm)
 1.8cm jaw



24-398-07
 2 3/4" (70mm)
 2.0cm jaw



24-398-09
 3 1/2" (90mm)
 2.5cm jaw



24-398-11
 4 1/2" (114mm)
 6.0cm jaw

**GLOVER BULLDOG CLAMP
 STRAIGHT**



24-399-06
 2 1/2" (63mm)
 1.8cm jaw



24-399-07
 2 3/4" (70mm)
 2.0cm jaw



24-399-08
 3 1/2" (90mm)
 2.5cm jaw



24-399-11
 4 1/2" (114mm)
 6.0cm jaw

**GLOVER BULLDOG CLAMP
 CURVED**

CARDIOVASCULAR INSTRUMENTS

BULLDOG CLAMPS

Atrauma

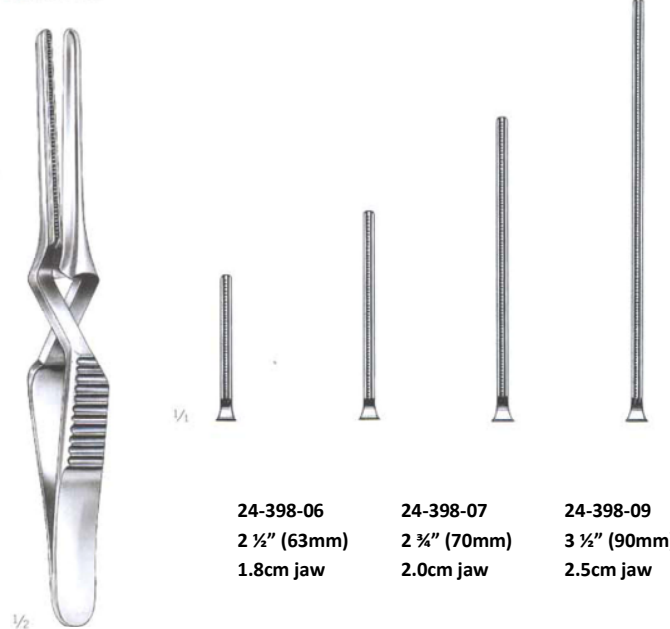

- | | | | |
|-------------|-------------|-------------|--------------|
| 24-398-06 | 24-398-07 | 24-398-09 | 24-398-11 |
| 2 ½" (63mm) | 2 ¾" (70mm) | 3 ½" (90mm) | 4 ½" (114mm) |
| 1.8cm jaw | 2.0cm jaw | 2.5cm jaw | 6.0cm jaw |

**GLOVER BULLDOG CLAMP
STRAIGHT**

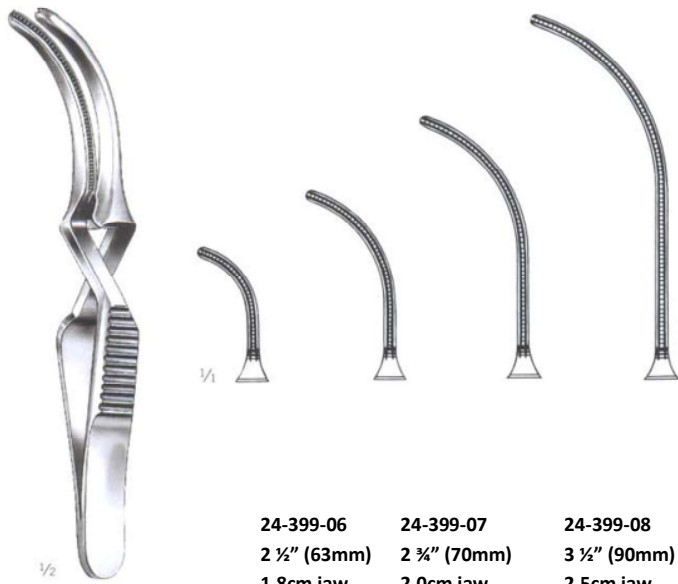

- | | | | |
|-------------|-------------|-------------|--------------|
| 24-399-06 | 24-399-07 | 24-399-08 | 24-399-11 |
| 2 ½" (63mm) | 2 ¾" (70mm) | 3 ½" (90mm) | 4 ½" (114mm) |
| 1.8cm jaw | 2.0cm jaw | 2.5cm jaw | 6.0cm jaw |

**GLOVER BULLDOG CLAMP
CURVED**

CARDIOVASCULAR INSTRUMENTS

BULLDOG & PEDIATRIC CLAMPS

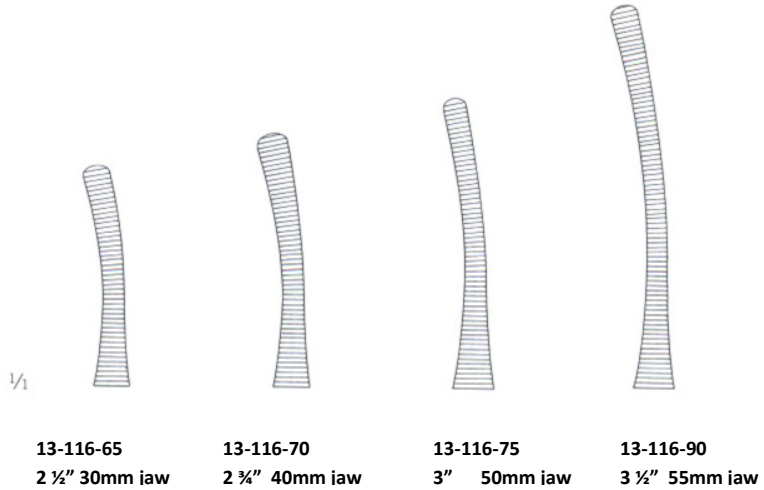
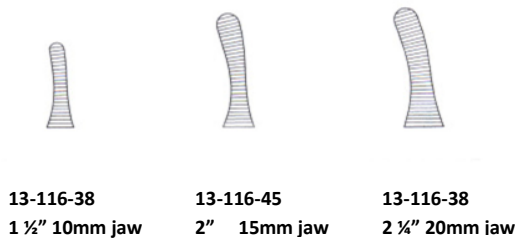

JOHN-HOPKINS BULLDOG CLAMPS CURVED

Atrauma



COOLE-DERRA PEDIATRIC CLAMPS 16.5cm, 6 1/2"

CARDIOVASCULAR INSTRUMENTS

MULTI PURPOSE VASCULAR CLAMPS

Atrauma



1/4

24-437-20
 21cm, 8 1/2"

24-437-21
 22cm, 8 3/4"

24-437-25
 26cm, 10"

24-437-29
 21cm, 8 1/2"



1/2

DE BAKY MULTI PURPOSE VASCULAR CLAMPS

THORACIC INSTRUMENTS

LUNG GRASPING FORCEPS & KNIFE

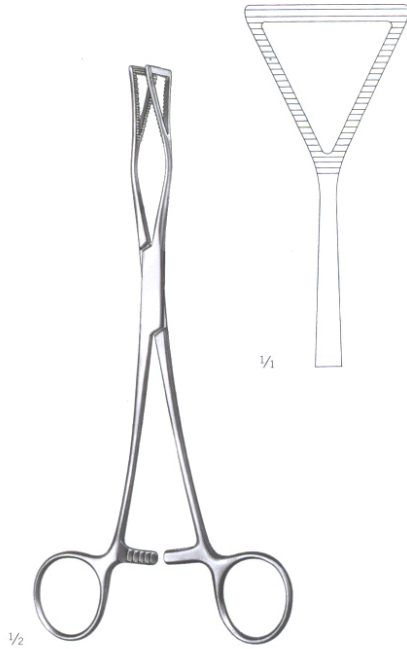

LOVELACE LUNG FORCEPS STRAIGHT
 24-286-20 20cm, 8"

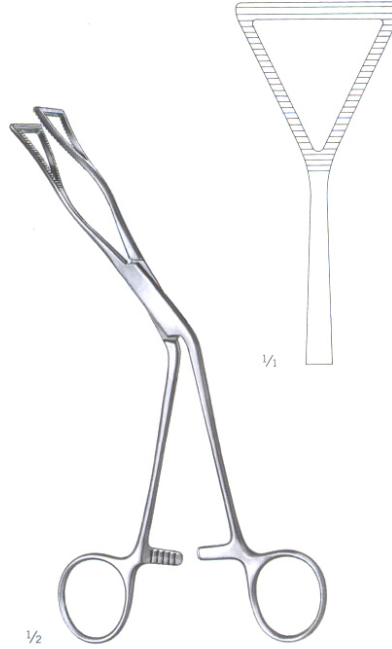

LOVELACE LUNG FORCEPS ANGLED
 24-287-20 19cm, 7 1/2"

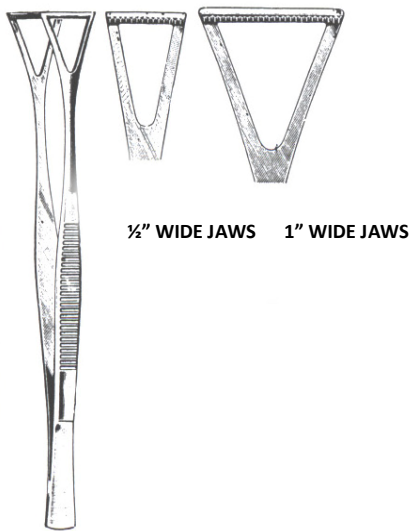

COLLIN-DUVAL LUNG GRASPING FORCEPS
 24-280-20 20cm, 8"
 24-281-20 20cm, 8"



LEBSCHKE KNIFE
 24-151-24 10" 25cm

THORACIC INSTRUMENTS

HEMOSTATIC FORCEPS



MIXTER FORCEPS
13-485-23
9" 23 cm



MIXTER FORCEPS
13-495-28
11" 28 cm

THORACIC INSTRUMENTS

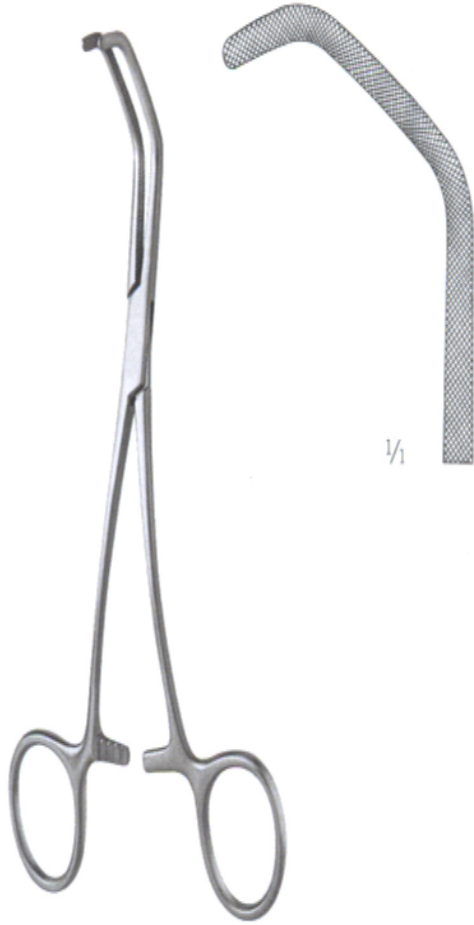

SATINSKY VENA CAVA CLAMPS
24-425-27 27cm, 10½"

HEMOSTATIC FORCEPS



PENNINGTON FORCEPS
13-280-20 20cm, 8"

THORACIC INSTRUMENTS

RIB RETRACTORS

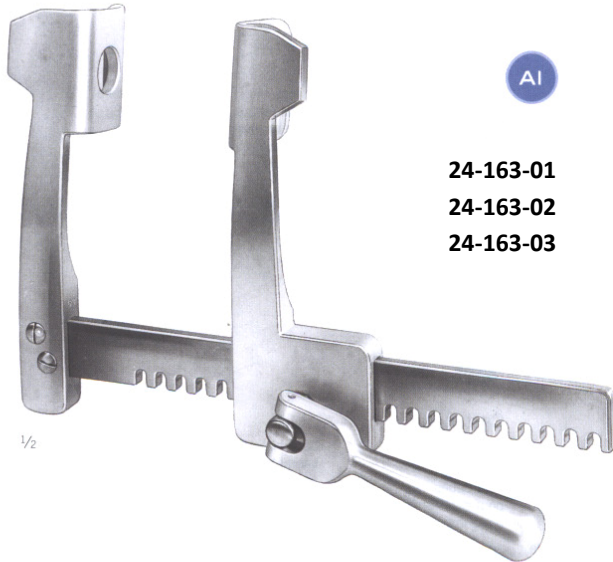

AI

FINOCHIETTO RIB SPREADER

24-163-01

SMALL 1 3/4" X 1 3/4" BLADES, 6" SPREAD

24-163-02

MEDIUM 1 3/4" X 2 1/4" BLADES, 10" SPREAD

24-163-03

LARGE 2 3/4" X 2 1/2" BLADES, 12" SPREAD

AI

BURFORD-FINOCHIETTO, RETRACTOR



24-165-01

ANODIZED ALUMINIUM 8" SPREAD

24-165-02

ANODIZED ALUMINIUM 10" SPREAD

24-165-03

ANODIZED ALUMINIUM 12" SPREAD

THORACIC INSTRUMENTS

RIB RETRACTORS

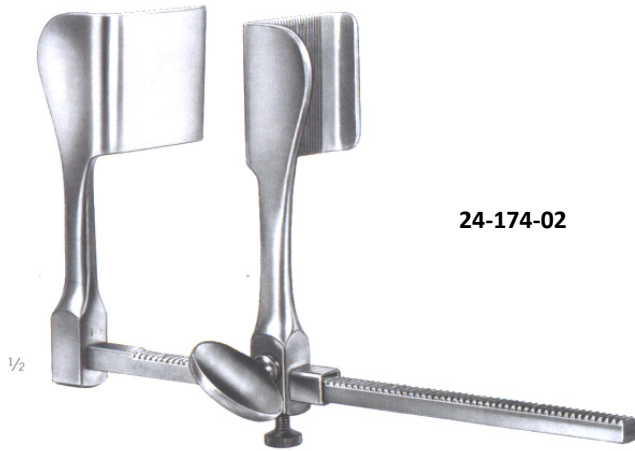

TUFFIER RIB SPREADER

24-174-02

LARGE 2" X 1 3/4" BLADES WITH 6 1/2" SPREAD

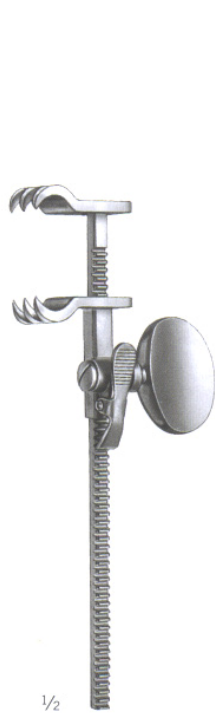

BAILEY BABY RIB CONTRACTORS
24-220-14
6 1/4" (155mm)



BAILEY RIB CONTRACTORS
24-224-16
7 3/4" (200mm)

THORACIC INSTRUMENTS

RIB ELEVATORS



1/2



23-441-17
RIGHT

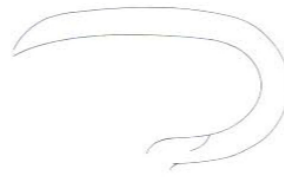

23-443-17
LEFT

DOYEN RIB ELEVATOR CURVED
7" 18cm



1/2

ALEXANDER ELEVATOR
23-448-21 8 3/4" 20cm



MATSON RIB ELEVATOR
23-449-22 8 3/4" 22cm

THORACIC INSTRUMENTS

RIB SHEARS



BONE SHAERS
24-100-23 9" (230mm)



BONE SHAERS
24-101-22 9" (230mm)



GLUCK RIB SHEARS
24-107-22 8 3/4" (210mm)



BETHUNE RIB SHEARS
24-126-34 13 1/2" (340mm)



SAUERBRUCH RIB SHEARS
24-131-26 10 1/2" (260mm)



GIERTZ-STILLE RIB SHEARS
24-137-27 9 3/4" (245mm)

STERILIZING AIDS

INSTRUMENTS STRINGERS

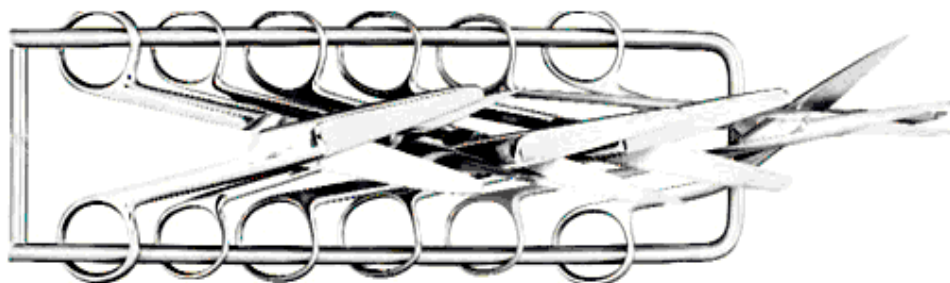

<u>55-150-86</u>	<u>STRINGER – OPEN U</u>	<u>2 ½" x 10"</u>
<u>55-150-89</u>	<u>STRINGER – OPEN U</u>	<u>2 ½" x 12"</u>

55-150-86 to 55-150-89



<u>55-150-90</u>	<u>STRINGER – CENTER LOCK</u>	<u>2 ½" x 6"</u>
<u>55-150-91</u>	<u>STRINGER – CENTER LOCK</u>	<u>2 ½" x 8"</u>
<u>55-150-92</u>	<u>STRINGER – CENTER LOCK</u>	<u>2 ½" x 10"</u>
<u>55-150-93</u>	<u>STRINGER – CENTER LOCK</u>	<u>2 ½" x 12"</u>
<u>55-150-94</u>	<u>STRINGER – CENTER LOCK</u>	<u>2 ½" x 16"</u>
<u>55-150-95</u>	<u>STRINGER – CENTER LOCK</u>	<u>2 ½" x 18"</u>
<u>55-150-96</u>	<u>STRINGER – CLOSED U</u>	<u>2 ½" x 6"</u>
<u>55-150-97</u>	<u>STRINGER – CLOSED U</u>	<u>2 ½" x 8"</u>
<u>55-150-98</u>	<u>STRINGER – CLOSED U</u>	<u>2 ½" x 10"</u>
<u>55-150-99</u>	<u>STRINGER – CLOSED U</u>	<u>2 ½" x 12"</u>
<u>55-151-100</u>	<u>STRINGER – CLOSED U</u>	<u>2 ½" x 16"</u>
<u>55-151-101</u>	<u>STRINGER – CLOSED U</u>	<u>2 ½" x 18"</u>
<u>55-151-102</u>	<u>STRINGER – CLOSED U</u>	<u>2 ½" x 20"</u>

55-150-90 to 55-150-95

55-150-96 to 55-151-102

STERILIZING AIDS

INSTRUMENTS RACKS



55-160-01



55-160-05
 55-160-06



55-160-09
 55-160-10

55-160-01

BLUNT FORCEPS HOLDER 4 3/4"

55-160-05

INSTRUMENT HOLDERS (Stringers) 6", "T" Bar 15.2cm

55-160-06

INSTRUMENT HOLDERS (Stringers) 12", "T" Bar 30.5cm

55-160-09

WEINSTEIN Instruments Sterlizing Rack, Small, 5 1/2" x 3"

55-160-10

WEINSTEIN Instruments Sterlizing Rack, Small, 11 1/4" x 3"

STERLIZING AIDS

STERLIZING FORCEPS



- 55-162-01
- 55-162-02
- 55-162-03
- 55-162-04
- 55-162-05
- 55-162-06



- 55-164-01
- 55-164-02



- 55-166-01
- 55-166-02

- 55-162-01
- 55-162-02
- 55-162-03
- 55-162-04
- 55-162-05
- 55-162-06
- 55-162-07

- LAPARATOMY RINGS, 1" (2.5 cm)
- LAPARATOMY RINGS, 1 ¼" (3.1 cm)
- LAPARATOMY RINGS, 1 ½" (3.8 cm)
- LAPARATOMY RINGS, 1 ¾" (4.4 cm)
- LAPARATOMY RINGS, 2" (5.1 cm)
- LAPARATOMY RINGS, 2 ¼" (5.72 cm)
- LAPARATOMY RINGS, 2 ½" (6.4 cm)

- 55-164-01
- 55-164-02

- UTILITY & STERLIZING FORCEPS, STRAIGHT, 8" (20.3 cm)
- UTILITY & STERLIZING FORCEPS, STRAIGHT, 11" (27.9 cm)

- 55-166-01
- 55-166-02

- UTILITY & STERLIZING FORCEPS, CURVED, 8" (20.3 cm)
- UTILITY & STERLIZING FORCEPS, CURVED, 11" (27.9 cm)

- 55-085-27

- CHEATLE STERLIZING FORCEPS, 11" (27.9 cm)



- 55-085-27