

10

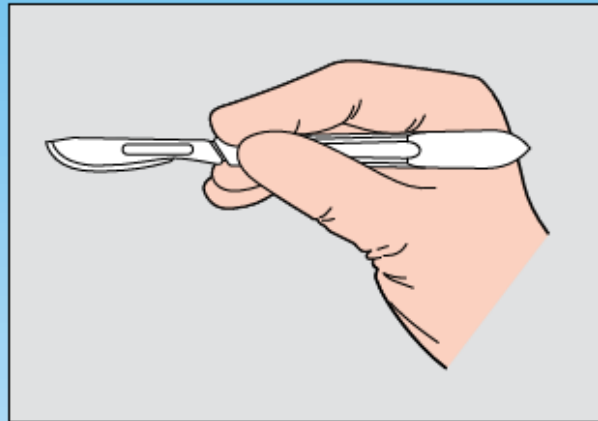

Scalpels

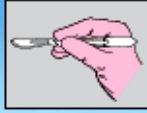

Scalpels
Scalpel Handles

10

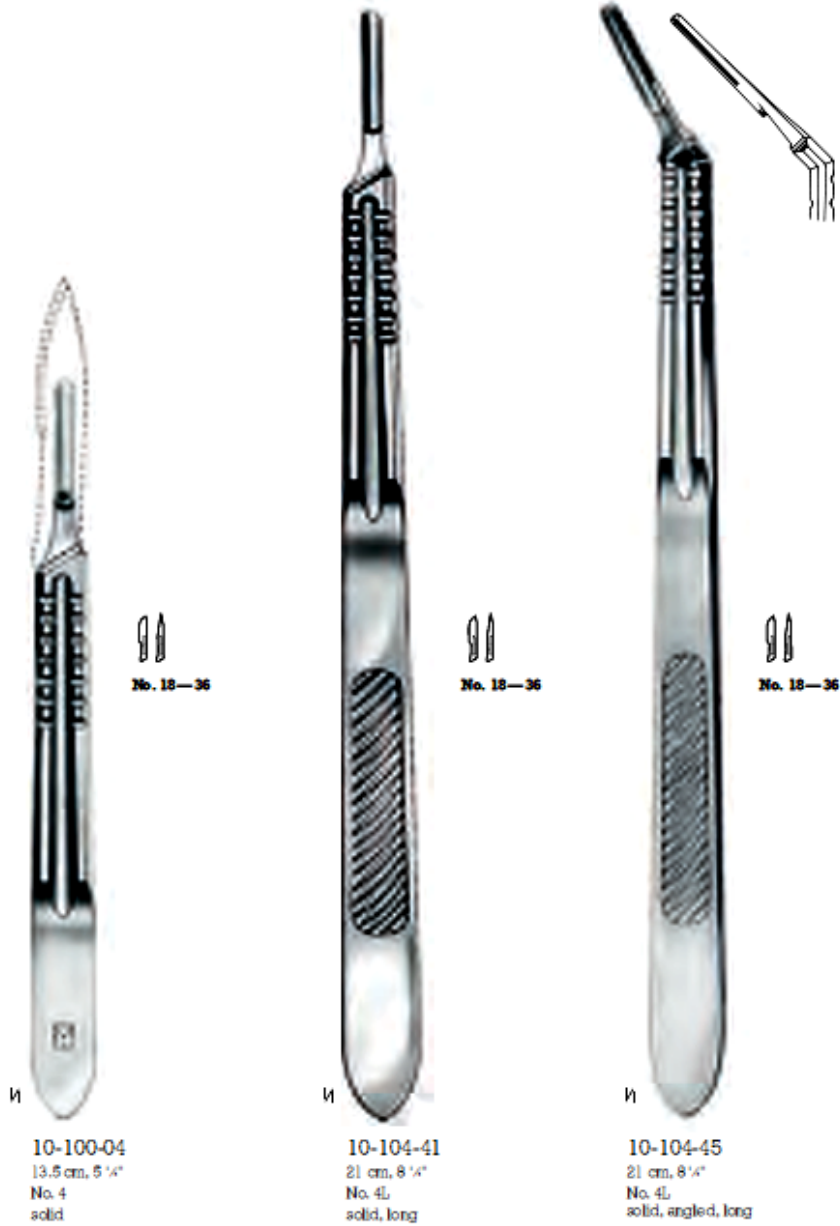

10-100-04
13.5 cm, 5 1/4"
No. 4
solid

10-104-41
21 cm, 8 1/4"
No. 4L
solid, long

10-104-45
21 cm, 8 1/4"
No. 4L
solid, angled, long

Scalpels
Scalpel Handles



10

Best Seller



No. 10-17

10-130-03
No. 3
12 cm, 4 1/4"
solid



No. 10-17

10-130-04
No. 3
12 cm, 4 1/4"
solid, handle style as no. 4

Best Seller



No. 10-17

10-130-05
No. 3
12 cm, 4 1/4"
solid, cm-graduation



No. 10-17

10-133-31
No. 3L
21.5 cm, 8 1/4"
solid, long



Scalpels
Scalpel Handles

10

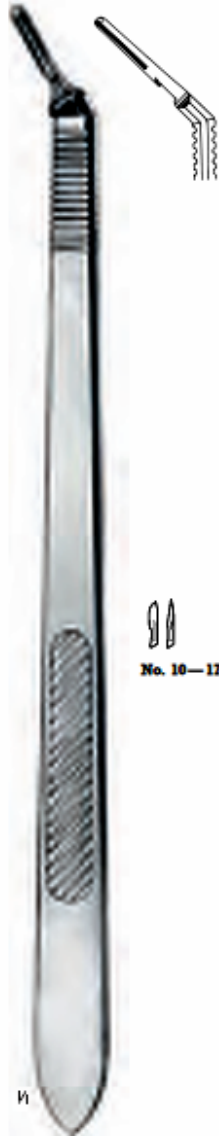

10-133-35
No. 3L
21 cm, 8 1/4"
solid, angled, long



10-137-07
No. 7
16 cm, 6 1/4"
solid



10-137-71
No. 7K
12.5 cm, 5"
solid, short

Scalpels
Scalpel Handles

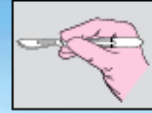

10



No. 10—17

10-140-03
No. 3
15.5 cm, 6"
with round hollow handle



No. 10—17

10-146-03
No. 3
14.5 cm, 5 1/4"
solid, round



No. 10—17

10-147-03
No. 3
14 cm, 5 1/4"
solid, round, angled



No. 10—17

Kaye
10-148-03
No. 3
15 cm, 6"
solid, round



Scalpels
Scalpel Blades

10

Best Seller



single packed - sterile
100 blades per box



sterile					
10-155-10	10-155-11	10-155-12	10-155-15	10-155-17	10-155-20
Fig. 10	Fig. 11	Fig. 12	Fig. 15	Fig. 17	Fig. 20



sterile				
10-155-22	10-155-25	10-155-34	10-156-12	10-156-15
Fig. 22	Fig. 25	Fig. 34	Fig. 12 D	Fig. 15 C

Scalpels
Scalpel Handles, Micro Scalpel Blades

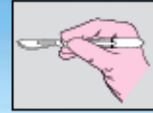

Titanium



11



11



11

single packed - sterile
25 blades per box







sterile				
10-160-61	10-160-62	10-160-63	10-160-64	10-160-65
Fig. 61	Fig. 62	Fig. 63	Fig. 64	Fig. 65







sterile			
10-160-66	10-160-67	10-160-68	10-160-69
Fig. 66	Fig. 67	Fig. 68	Fig. 69

<p>Beaver type 01-012-10 10 cm, 4"</p>	<p>10-159-00 13.5 cm, 5 1/4"</p>	<p>10-160-00 14 cm, 5 1/4"</p>	
<p>01-012-11 13 cm, 5"</p>	<p>for micro scalpel blades, titanium</p>	<p>for micro scalpel blades</p>	
<p>01-012-12 15 cm, 6"</p>			
	<p>for micro scalpel blades</p>		

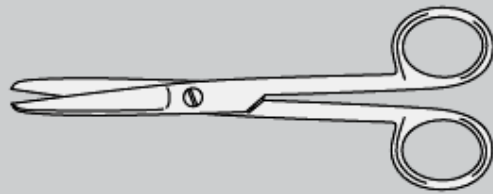
11



Scissors

ELMED
Serving the Medical Profession Since 1955



PRIMAX
German Surgical Instruments Since 1955



Scissors
Dissecting Scissors

11



1/2

Littler



1/1

00-101-02
11.5 cm, 4 1/4"



1/2

Littler



1/1

00-101-64
14 cm, 5 1/4"
hole located at distal end
of scissor for passing
suture for tendon pulling



1/2

00-102-04
double curved TMJ
14 cm, 5 1/4"



1/2

Lilly
00-103-85
19 cm, 7 1/4"
tonsil scissors

Scissors
Super-Edge
Dissecting Scissors

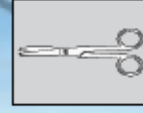

1/2 Mayo
Super-Edge



1/1 11-002-14
14 cm, 5 1/4"
straight, serrated



11-002-17
17 cm, 6 1/4"
straight, serrated



11-003-14
14.5 cm, 5 1/4"
curved, serrated



11-003-17
17 cm, 6 1/4"
curved, serrated



11

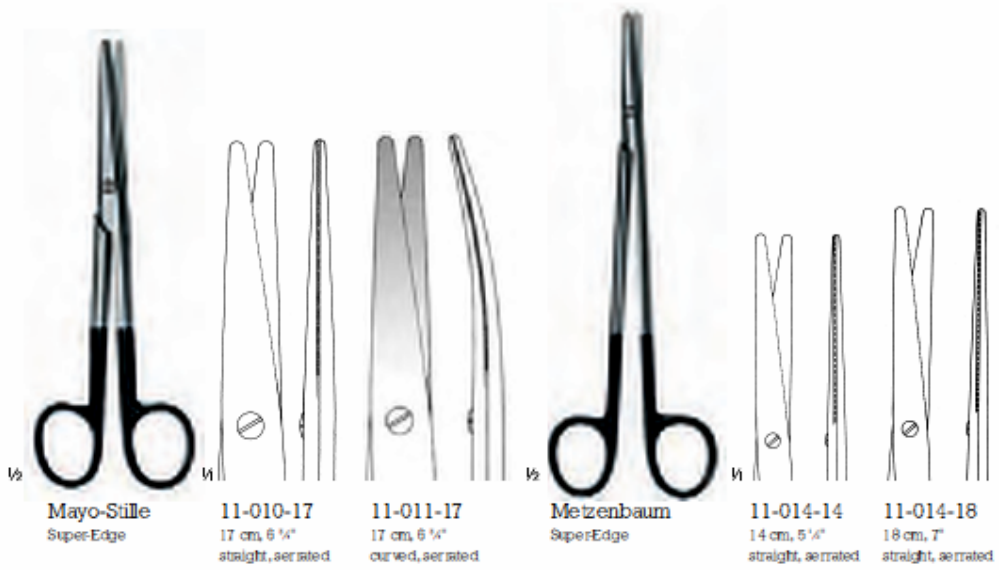

PRIMAX 
German Surgical Instruments Since 1955

ELMED 
Serving the Medical Profession Since 1955

Scissors 
Super-Edge
Dissecting Scissors



11



1/2
Metzenbaum
Super-Edge
curved, serrated



1/4
11-015-14
14 cm, 5 1/4"



11-015-18
18 cm, 7"

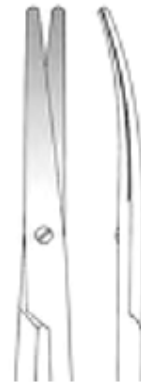

11-015-20
20 cm, 8"



11-015-23
23 cm, 9"

ELMED
Serving the Medical Profession Since 1955



PRIMAX
German Surgical Instruments Since 1955



Scissors
Super-Edge
Dissecting Scissors

11



h₂ h₁

Metzenbaum
Super-Edge
delicate



11-016-14
14 cm, 5 1/2"
straight, serrated



11-016-18
18 cm, 7"
straight, serrated



h₂ h₁

Metzenbaum
Super-Edge
delicate



11-017-14
14 cm, 5 1/2"
curved, serrated



11-017-18
18 cm, 7"
curved, serrated

Scissors
 Super-Edge
 Fine Dissecting Scissors



Iris
 Super-Edge



11-020-11
 11.5 cm, 4 1/2"
 straight, serrated



11-021-11
 11.5 cm, 4 1/2"
 curved, serrated



Par
 Super-Edge



11-024-11
 11.5 cm, 4 1/2"
 straight, serrated



11-025-11
 11.5 cm, 4 1/2"
 curved, serrated



11



Stevens
Super-Edge

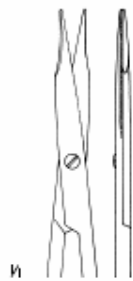

11-028-11
11.5 cm, 4 1/2"
straight, serrated
blunt



11-029-11
11.5 cm, 4 1/2"
curved, serrated
blunt



Stevens
Super-Edge

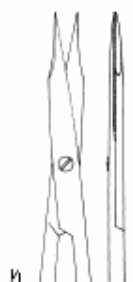

11-030-11
11.5 cm, 4 1/2"
straight, serrated
sharp



11-031-11
11.5 cm, 4 1/2"
curved, serrated
sharp



Wagner
Super-Edge



11-034-12
11.5 cm, 4 1/2"
straight, serrated
sharp

Scissors
Super-Edge
Fine Dissecting Scissors

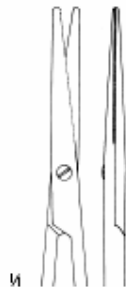

1/2

1/1

Strabismus
Super-Edge

11-040-11
11 cm, 4 1/4"
straight, serrated



1/2

1/1

Joseph
Super-Edge

11-042-14
14 cm, 5 1/2"
straight, serrated



11-043-14
14 cm, 5 1/2"
curved, serrated



1/2

1/1

Goldman-Fox
Super-Edge

11-051-13
13 cm, 5"
curved, serrated



1/2

1/1

Reynolds
Super-Edge

11-055-14
14 cm, 5 1/2"
curved, serrated



11-055-16
16 cm, 6 1/4"
curved, serrated

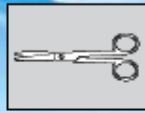

Scissors
Operating Scissors

11



1/2



1/4

11-100-11
11.5 cm, 4 1/2"
straight,
blunt/blunt

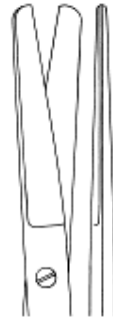

11-100-13
13.0 cm, 5"
straight,
blunt/blunt



11-100-14
14.5 cm, 5 1/2"
straight,
blunt/blunt



11-100-16
16.5 cm, 6 1/2"
straight,
blunt/blunt



1/2



1/4

11-102-11
11.5 cm, 4 1/2"
straight,
sharp/blunt



11-102-13
13.0 cm, 5"
straight,
sharp/blunt



11-102-14
14.5 cm, 5 1/2"
straight,
sharp/blunt

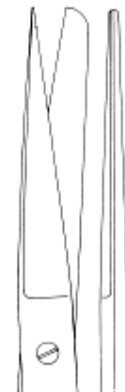

11-102-16
16.5 cm, 6 1/2"
straight,
sharp/blunt

Scissors 
 Operating Scissors



11



1/2



1/4

11-104-11
 11.5 cm, 4 1/2"
 straight,
 sharp/sharp



11-104-13
 13.0 cm, 5"
 straight,
 sharp/sharp



11-104-14
 14.5 cm, 5 1/4"
 straight,
 sharp/sharp

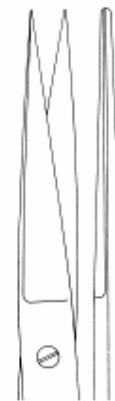

11-104-16
 16.5 cm, 6 1/2"
 straight,
 sharp/sharp



1/2



1/4

11-105-11
 11.5 cm, 4 1/2"
 curved,
 blunt/blunt



11-105-13
 13.0 cm, 5"
 curved,
 blunt/blunt



11-105-14
 14.5 cm, 5 1/4"
 curved,
 blunt/blunt



11-105-16
 16.5 cm, 6 1/2"
 curved,
 blunt/blunt

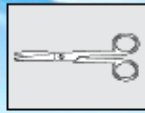

Scissors
Operating Scissors

11



1/2



1/4

11-107-11
11.5 cm, 4 1/2"
curved,
sharp/blunt



11-107-13
13 cm, 5"
curved,
sharp/blunt



11-107-14
14.5 cm, 5 1/2"
curved,
sharp/blunt



11-107-16
16.5 cm, 6 1/2"
curved,
sharp/blunt



1/2



1/4

11-109-11
11.5 cm, 4 1/2"
curved,
sharp/sharp



11-109-13
13 cm, 5"
curved,
sharp/sharp



11-109-14
14.5 cm, 5 1/2"
curved,
sharp/sharp



11-109-16
16.5 cm, 6 1/2"
curved,
sharp/sharp

PRIMAX 
German Surgical Instruments Since 1955

ELMED 
Serving the Medical Profession Since 1955

Scissors
Dissecting Scissors



11



Mayo



11-170-14
14 cm, 5 1/2"
straight



11-170-15
15 cm, 6"
straight



11-170-17
17 cm, 6 1/2"
straight



11-170-23
23 cm, 9"
straight

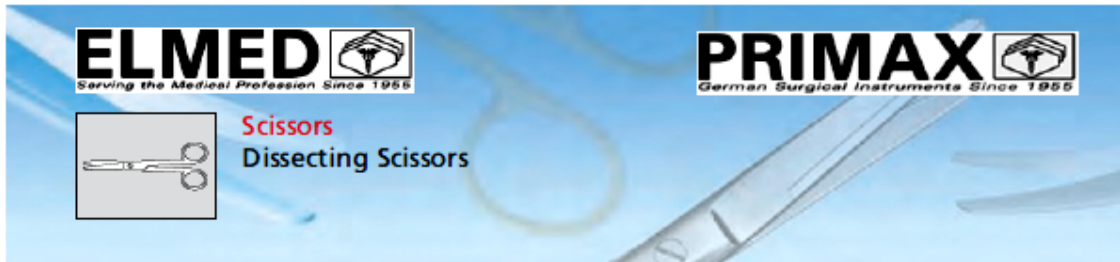

11

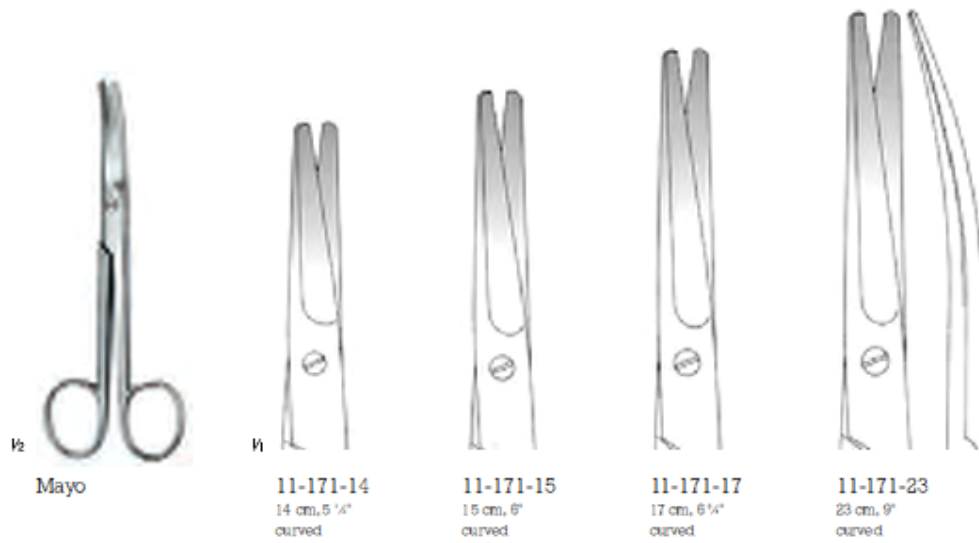

Scissors
 Dissecting Scissors



1/2
 Mayo-Style

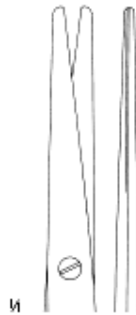

11-180-15
 15 cm, 6"
 straight



11-180-17
 17 cm, 6 1/4"
 straight



11-181-15
 15 cm, 6"
 curved



11-181-17
 17 cm, 6 1/4"
 curved

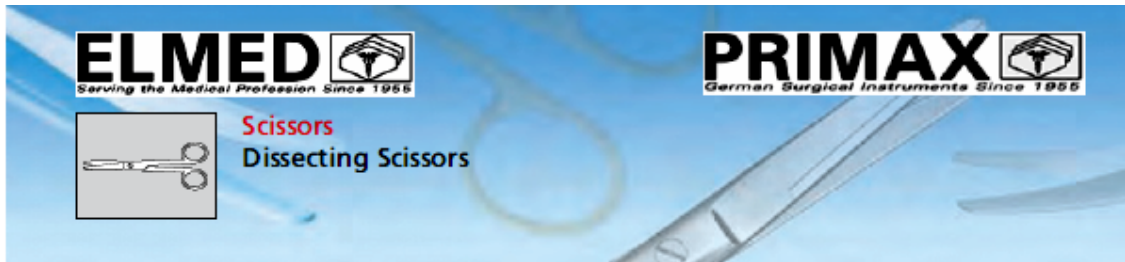

11

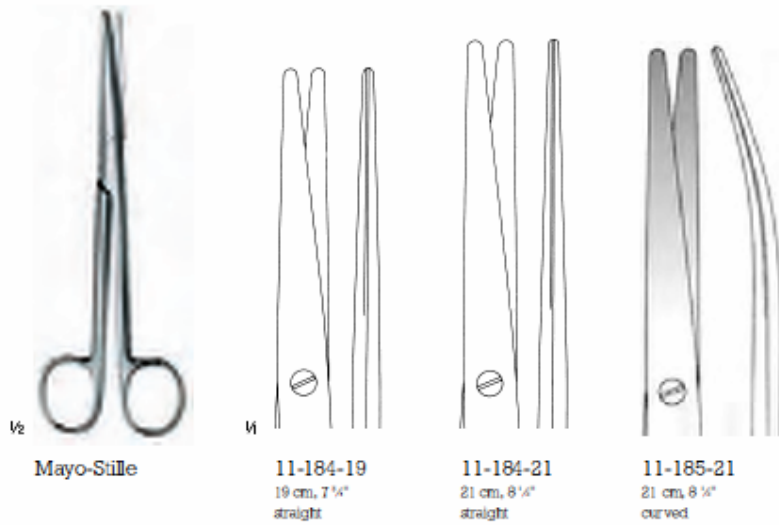

PRIMAX 
German Surgical Instruments Since 1955

ELMED 
Serving the Medical Profession Since 1955

Scissors
Dissecting Scissors

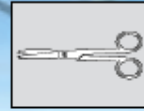

11



Mayo-Noble



11-190-17
17 cm, 6 1/4"
straight



11-191-17
17 cm, 6 1/4"
curved



Scissors
Dissecting Scissors

11



Kelly

Best Seller



11-226-16
16 cm, 6 1/4"
straight



11-227-16
16 cm, 6 1/4"
curved



Metzenbaum

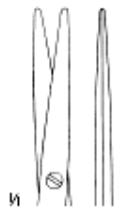

11-248-11
11.5 cm, 4 1/2"
straight



11-249-11
11.5 cm, 4 1/2"
curved

Scissors
 Dissecting Scissors



Metzenbaum



11-250-14
 14.5 cm, 5 1/4"
 straight
 blunt/blunt



11-252-14
 14.5 cm, 5 1/4"
 straight
 sharp/blunt



11-254-14
 14.5 cm, 5 1/4"
 straight
 sharp/sharp



11-255-14
 14.5 cm, 5 1/4"
 curved
 blunt/blunt



11-257-14
 14.5 cm, 5 1/4"
 curved
 sharp/blunt



11-259-14
 14.5 cm, 5 1/4"
 curved
 sharp/sharp



Metzenbaum



11-264-15
 15 cm, 6"
 straight



11-265-15
 15 cm, 6"
 curved

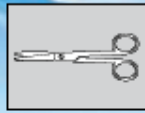

Scissors
Dissecting Scissors

11



Metzenbaum-Nelson



11-280-18
18 cm, 7"
straight



11-280-20
20 cm, 8"
straight



11-280-23
23 cm, 9"
straight



Metzenbaum-Nelson



11-285-18
18 cm, 7"
curved



11-285-20
20 cm, 8"
curved



11-285-23
23 cm, 9"
curved

Scissors
 Dissecting Scissors



Metzenbaum



11-298-14
 14.5 cm, 5 1/4"
 straight, serrated
 sharp/sharp



11-299-14
 14.5 cm, 5 1/4"
 curved, serrated
 sharp/sharp



Metzenbaum
 nerve preparing scissors
 sharp tips for delicate precise
 cutting



11-300-15
 15.5 cm, 6"
 straight
 sharp/sharp



11-301-15
 15.5 cm, 6"
 curved
 sharp/sharp

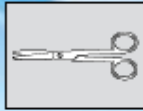

Scissors
Face-Lift Scissors

11



1/2

Kaye

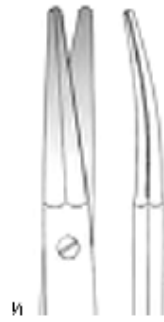

1/1

11-305-00
18.5 cm, 7 1/4"
curved, serrated



1/2

Rees



1/1

11-305-12
12 cm, 4 1/4"
curved, serrated



11-305-14
14 cm, 5 1/4"
curved, serrated



11-305-17
17 cm, 6 1/4"
curved, serrated



11-305-19
19.5 cm, 7 1/2"
curved, serrated

Scissors
 Face-Lift Scissors



Gorney

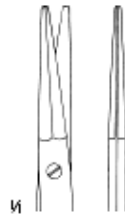

11-306-12
 12.5 cm, 5"
 straight

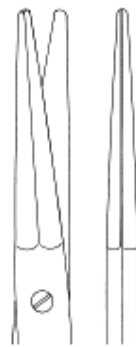

11-306-19
 19.5 cm, 7 1/4"
 straight



11-307-19
 19.5 cm, 7 1/4"
 curved



Aston



11-308-17
 17 cm, 6 1/4"
 straight

For more Face-Lift scissors see
 end of this section and section 28.

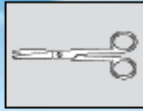

Scissors
Dissecting Scissors, Face-Lift Scissors

11



Kaye
face-lift



11-309-13
13 cm, 5"
curved, serrated



11-309-15
15.5 cm, 6"
curved, serrated



11-309-18
18 cm, 7"
curved, serrated



Lexer
dissecting



11-310-16
16 cm, 6 1/4"
straight



11-311-16
16 cm, 6 1/4"
curved

Scissors

Nasal Scissors, Gall Bladder Scissors, Fine Dissecting Scissors



Cinelli
nasal



11-317-11
11.5 cm, 4 1/2"
strong curve



Fomon
nasal



11-317-14
14 cm, 5 1/2"
strong curve



Thorek
gall bladder



11-319-19
18 cm, 7"
strong curve



Baby-Lexer
delicate dissecting



11-320-10
10 cm, 4"
straight



11-321-10
10 cm, 4"
curved



Scissors
Delicate Dissecting Scissors

11



1/2

Lexer
delicate



1/1

11-324-16
16 cm, 6 1/4"
straight, delicate



1/2

Lexer
delicate



1/1

11-325-16
16 cm, 6 1/4"
curved, delicate

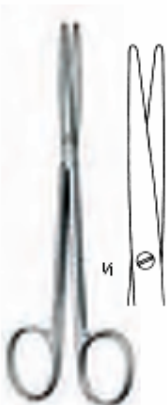

1/2

Metzenbaum
11-326-14
14.5 cm, 5 3/4"
straight, delicate



1/2

Metzenbaum
11-327-14
14.5 cm, 5 3/4"
curved, delicate

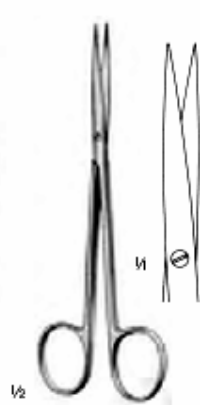

1/2

Metzenbaum
11-328-14
13.5 cm, 5 1/4"
straight, delicate
sharp/sharp

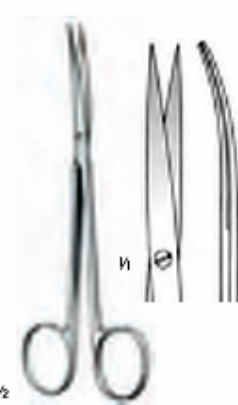

1/2

Metzenbaum
11-329-14
13.5 cm, 5 1/4"
curved, delicate
sharp/sharp

Scissors 
 Delicate Dissecting Scissors

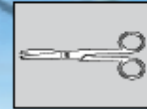

11

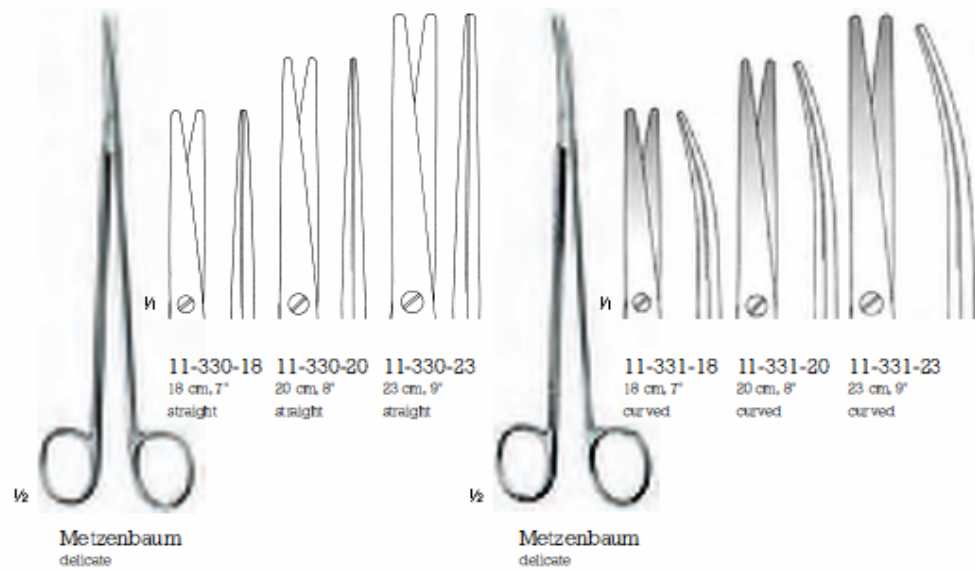



Scissors
Cleft Palate Scissors, Dissecting Scissors, Nasal Scissors

11



Salyer
cleft palate



11-339-12
12.5 cm, 5"
fine pattern
curved



11-339-18
18 cm, 7"
fine pattern
curved



Sarvenero
dissecting



11-340-14
14 cm, 5 1/2"
straight



11-341-14
14 cm, 5 1/2"
curved



Tenotomy
dissecting



11-344-11
11 cm, 4 1/4"
straight



11-345-11
11 cm, 4 1/4"
curved



Joseph
nasal



11-350-14
14 cm, 5 1/2"
straight



11-351-14
14 cm, 5 1/2"
curved

Scissors 
Dissecting Scissors



Peck-Joseph



11-352-14
14 cm, 5 1/4"
straight, sharp



11-353-14
14.5 cm, 5 1/4"
curved, sharp



11-354-14
14 cm, 5 1/4"
straight, blunt



11-355-14
14.5 cm, 5 1/4"
curved, blunt



Shea Vein Graf



11-357-12
12 cm, 4 1/4"
thin narrow tips
curved



Kilner



11-359-12
13 cm, 5"
curved



11-359-15
15 cm, 6"
curved



Scissors
Cleft Palate Scissors, Dissecting Scissors

11



1/2

Reynolds
dissecting



11-364-15
15 cm, 6"
straight

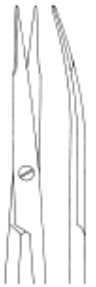

11-365-15
15 cm, 6"
curved



11-365-18
18 cm, 7"
curved



1/2

Jameson
dissecting



11-367-14
14.5 cm, 5 1/4"
curved,
regular blades



11-369-14
14.5 cm, 5 1/4"
curved,
serrated blades



1/2

Toennis-Adson
dissecting



11-459-17
17.5 cm, 7"
curved



1/2

Diethrich-Salyer
cleft palate



11-379-45
12.5 cm, 5"

Scissors
 Vascular Scissors



11

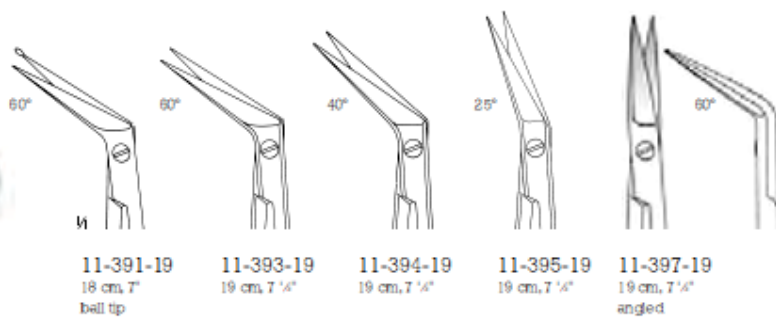
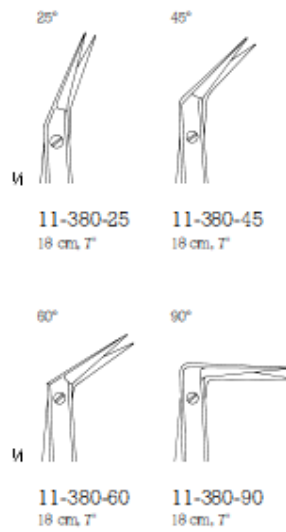

ELMED 
Serving the Medical Profession Since 1955

PRIMAX 
German Surgical Instruments Since 1955



Scissors
Nasal Scissors

TCGOLD

11



Fomon

11-503-15
15 cm, 6"
angled
serrated



Cottle

11-505-16
16.5 cm, 6 1/4"
angled
serrated

Scissors
 Nasal Scissors



11

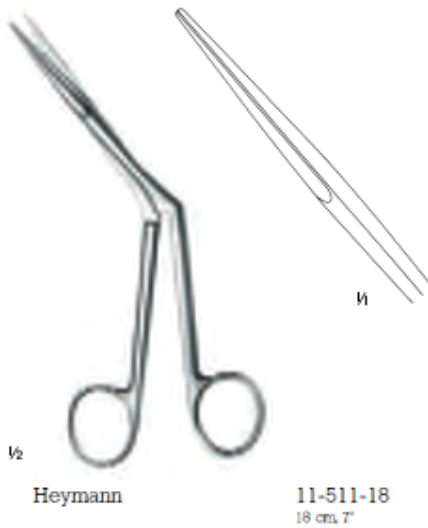
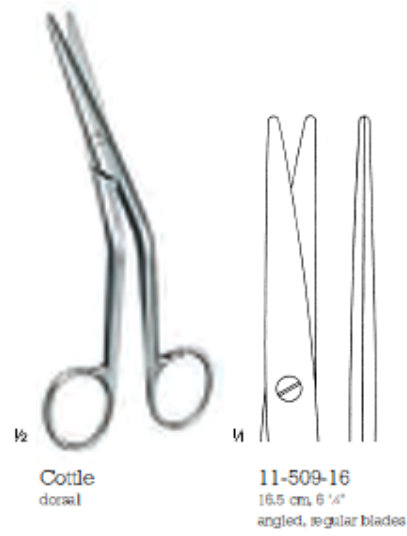

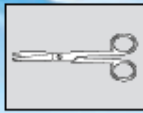

Scissors
Gum Scissors, Dissecting Scissors

11

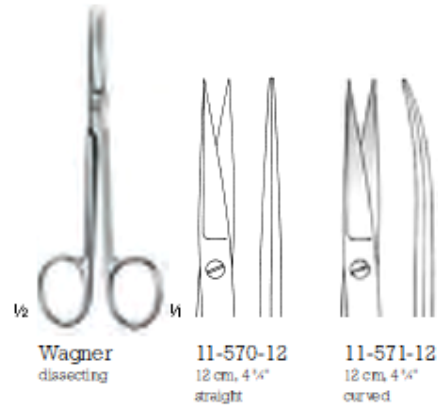

PRIMAX 
German Surgical Instruments Since 1955

ELMED 
Serving the Medical Profession Since 1955

Scissors 
Gum And Tonsil Scissors



11



v2

Dean
gum, tonsil

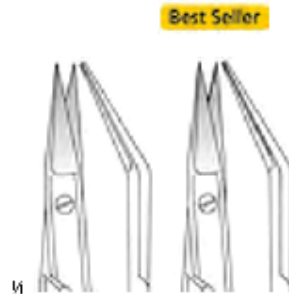

v1

11-496-17
17 cm, 6 1/4"

Best Seller
11-497-17
17 cm, 6 1/4"
serrated



11

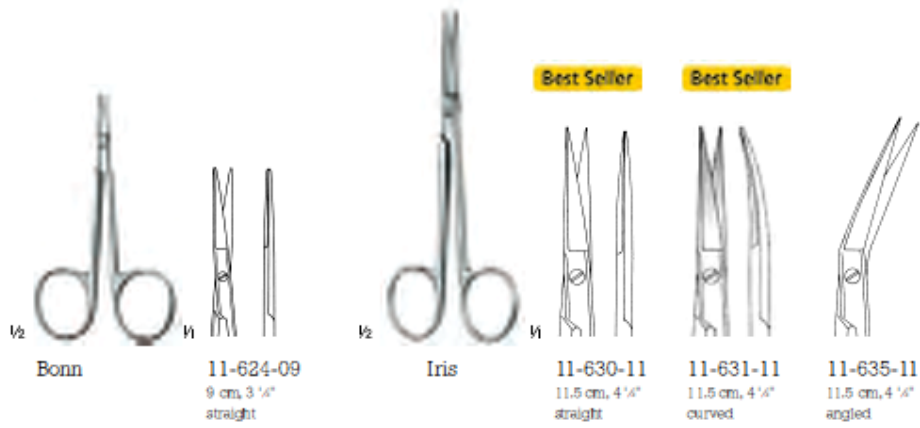

PRIMAX 
German Surgical Instruments Since 1956

ELMED 
Serving the Medical Profession Since 1956

Scissors 
Tenotomy Scissors



11

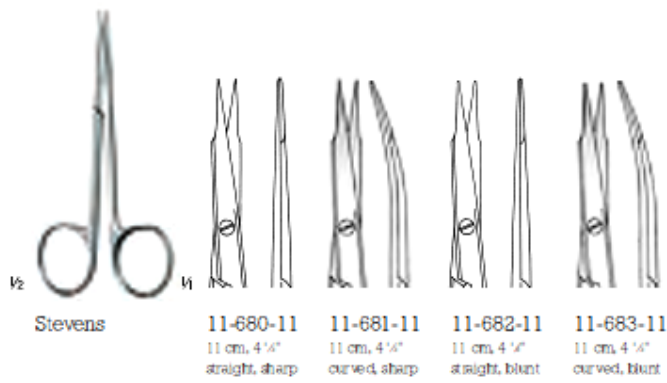



Scissors
Strabismus Scissors, Micro Scissors

11



Strabismus



11-690-11
11.5 cm, 4 1/4"
straight, blunt/blunt



11-691-11
11.5 cm, 4 1/4"
curved, blunt/blunt

 Steel

 Titanium



micro scissors



11-711-18
18 cm, 7"
steel, curved,
knurled handle



micro scissors



11-717-18
18 cm, 7"
titanium, curved,
knurled handle,
diamond coated cutting edges

Scissors
 Stitch Scissors, Micro Scissors



Westcott
 stitch



11-740-11
 11.5 cm, 4 1/4"
 straight



11-741-11
 11.5 cm, 4 1/4"
 curved



Jacobson
 11-732-23
 22.5 cm, 8 1/4"
 straight



Potts
 11-733-23
 22.5 cm, 8 1/4"
 curved



11-734-23
 23 cm, 9"
 straight



11-735-23
 23 cm, 9"
 curved



Scissors
Micro Scissors

11



11-748-19
18.5 cm, 7 1/4"
straight



11-749-19
18.5 cm, 7 1/4"
curved



11-755-11
11 cm, 4 1/4"
curved



11-750-19
18.5 cm, 7 1/4"
straight



11-751-19
18.5 cm, 7 1/4"
curved



11-752-19
19 cm, 7 1/2"
curved
downward



11-756-12
12 cm, 5"
straight

Scissors
 Micro Scissors

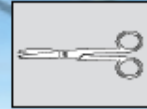

11



Gomel



11-757-14
 14 cm, 5 1/2"
 curved



11-757-16
 16 cm, 6 1/4"
 curved



Hepp/Scheidel



11-759-14
 14 cm, 5 1/2"
 curved



11-759-16
 16 cm, 6 1/4"
 curved



11-760-09
 9 cm, 3 1/4"
 straight



11-761-09
 9 cm, 3 1/4"
 angled



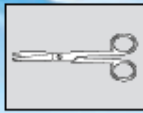

Scissors
Micro Scissors

11



1/2

1/4



Jaboma

11-765-18
18 cm, 7"
angled, ball-tip



1/2

1/4



Jaboma

11-767-18
18 cm, 7"
angled, ball-tip



1/2

1/4



Jaboma

11-769-18
18 cm, 7"
angled



1/2

1/4



11-773-00
14 cm, 5 1/2"
straight



11-773-01
15.5 cm, 6"
curved



Reill
11-773-02
15.5 cm, 6"
curved, serrated



1/2



1/4



1/4

11-774-01
18 cm, 7 1/4"
straight

11-774-02
18 cm, 7 1/4"
straight, one serrated blade



1/2



1/4



1/4

Hepp/Scheidel

11-775-01
18 cm, 7 1/4"
curved
blunt tips

11-775-03
18 cm, 7 1/4"
curved
sharp tips

ELMED 
Serving the Medical Profession Since 1956

PRIMAX 
German Surgical Instruments Since 1956

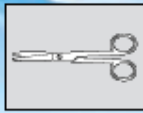

Scissors
Micro Scissors

11

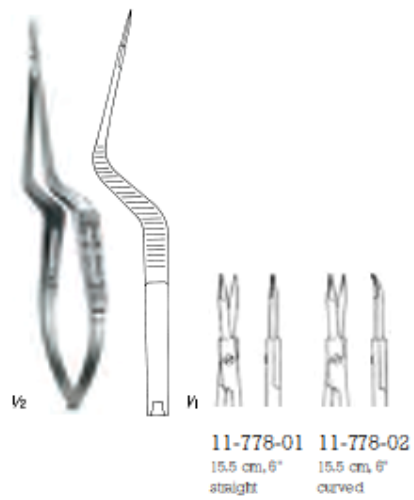
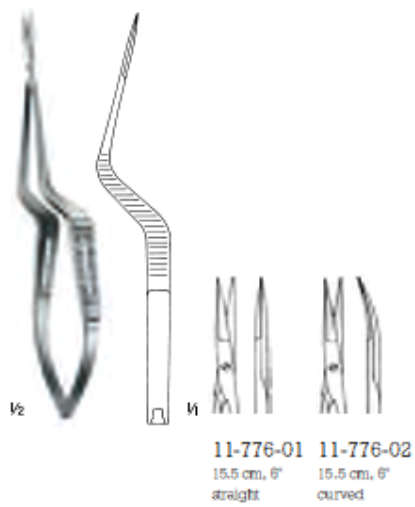

For more micro scissors, also see chapter 35.

Scissors
 Delicate Dissecting Scissors – Ribbon Type



1/2

Salyer



1/4

11-784-09
 9.5 cm, 3 1/4"
 ribbon type
 flat shanks, straight



1/2

Iris



1/4

11-786-09
 9.5 cm, 3 1/4"
 ribbon type
 flat shanks, straight



1/4

11-787-09
 9.5 cm, 3 1/4"
 ribbon type
 flat shanks, curved



1/2

Iris



1/4

11-788-10
 10 cm, 4"
 ribbon type
 flat shanks, straight



11-789-10
 10 cm, 4"
 ribbon type
 flat shanks, curved

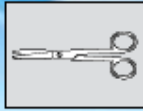

Scissors
Delicate Dissecting Scissors – Ribbon Type

11



Strabismus



11-792-10

10 cm, 4"
ribbon type
fat shanks, straight



11-793-10

10 cm, 4"
ribbon type
fat shanks, curved



Stevens



11-796-10

10 cm, 4"
ribbon type
fat shanks, sharp,
straight



11-797-10

10 cm, 4"
ribbon type
fat shanks, sharp,
curved



Stevens



11-798-10

10 cm, 4"
ribbon type
fat shanks, blunt,
straight



11-799-10

10 cm, 4"
ribbon type
fat shanks, blunt,
curved

Scissors
 Delicate Dissecting Scissors – Ribbon Type



1/2

Salyer



1/4

11-801-10
 10 cm, 4"
 ribbon type
 flat shanks, curved



1/4

Blepharoplasty



1/4

11-806-10
 10.5 cm, 4 1/8"
 ribbon type
 flat shanks, straight, sharp
 double beveled blades



11-807-10
 10.5 cm, 4 1/8"
 ribbon type

flat shanks, curved, sharp
 double beveled blades



1/2

Kaye



1/4

11-809-11
 11 cm, 4 1/8"
 ribbon type
 flat shanks, curved,
 serrated



1/2

Ragnell



1/4

11-811-10
 10 cm, 4"
 ribbon type
 flat shanks, curved,
 blunt



11

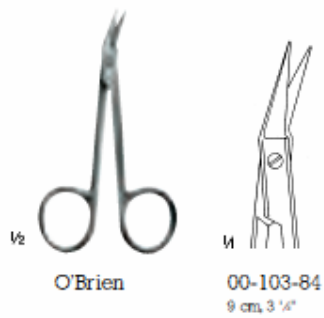
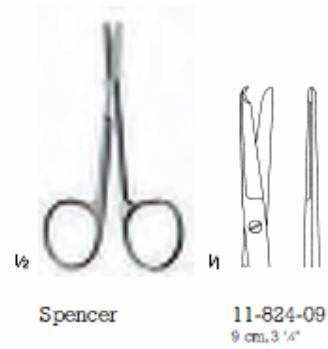

Scissors
 Suture Scissors



11

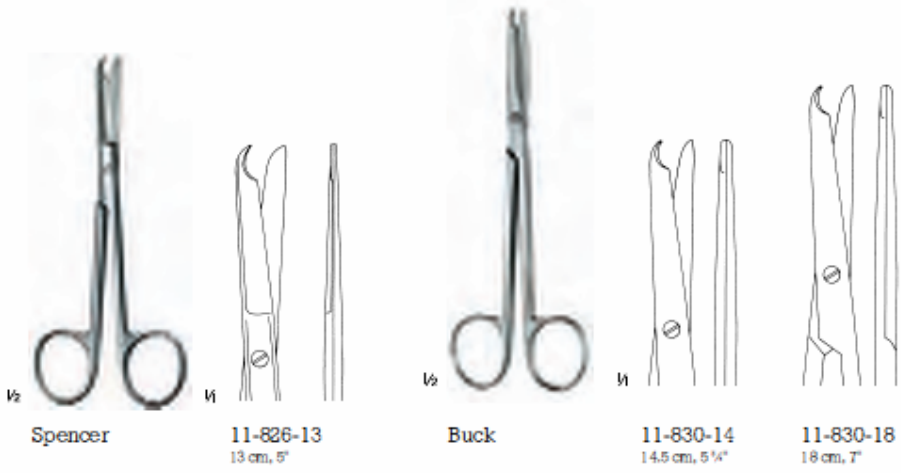



Scissors
Operating Scissors

TCGOLD

11



1/2

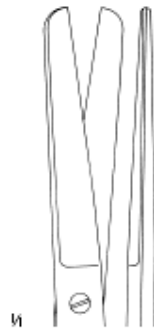

1/4

11-902-14
14.5 cm, 5 1/4"
straight
blunt/blunt



1/4

11-904-14
14.5 cm, 5 1/4"
straight
sharp/blunt



1/4

11-906-14
14.5 cm, 5 1/4"
straight
sharp/sharp



1/2



1/4

11-903-14
14.5 cm, 5 1/4"
curved
blunt/blunt



1/4

11-905-14
14.5 cm, 5 1/4"
curved
sharp/blunt



1/4

11-907-14
14.5 cm, 5 1/4"
curved
sharp/sharp

PRIMAX 
German Surgical Instruments Since 1955

ELMED 
Serving the Medical Profession Since 1955

Scissors
Dissecting Scissors



TCGOLD

11



1/2

Mayo



1/1

11-910-14
14.5 cm, 5 7/8"
straight

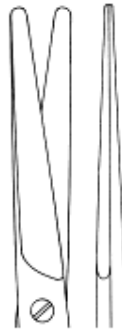

11-910-17
17 cm, 6 3/4"
straight



11-910-23
23 cm, 9"
straight



1/2

Mayo



1/1

11-911-14
14.5 cm, 5 7/8"
curved



11-911-17
17 cm, 6 3/4"
curved



11-911-23
23 cm, 9"
curved

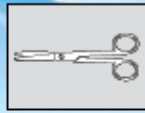

Scissors
Dissecting Scissors

TCGOLD

11



Mayo-Stille



11-930-15
15 cm, 6"
straight

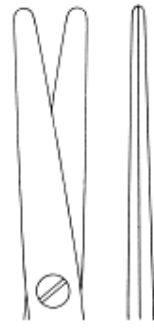

11-930-17
17 cm, 7"
straight



Mayo-Stille



11-931-15
15 cm, 6"
curved



11-931-17
17 cm, 7"
curved

Scissors
Dissecting Scissors



TCGOLD

11

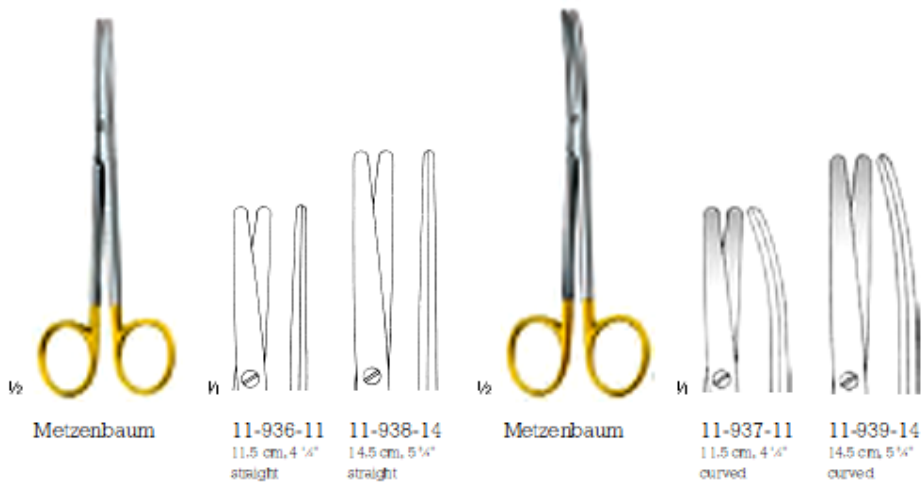

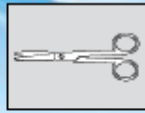

Scissors
Dissecting Scissors

TCGOLD

11



h/2

Metzenbaum



11-942-18
18 cm, 7"
straight



11-942-20
20 cm, 8"
straight

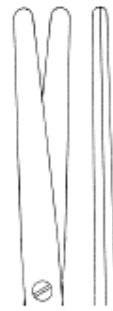

11-942-23
23 cm, 9"
straight



11-942-25
25 cm, 10"
straight



h/2

Metzenbaum



11-943-18
18 cm, 7"
curved



11-943-20
20 cm, 8"
curved



11-943-23
23 cm, 9"
curved



11-943-25
25 cm, 10"
curved



11-943-28
28 cm, 11"
curved



11-943-30
30 cm, 12"
curved

PRIMAX 
 German Surgical Instruments Since 1955

ELMED 
 Serving the Medical Profession Since 1955

Scissors
 Dissecting Scissors



TCGOLD

11

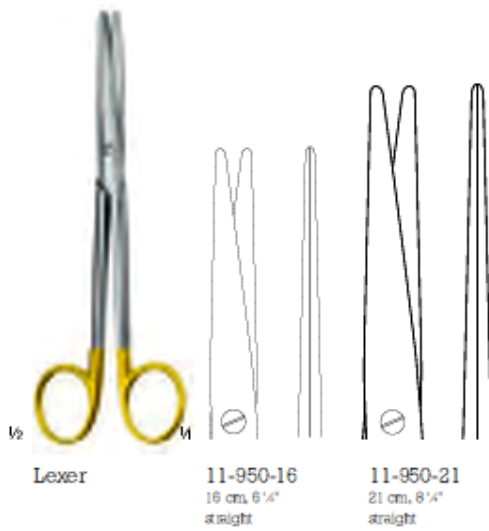
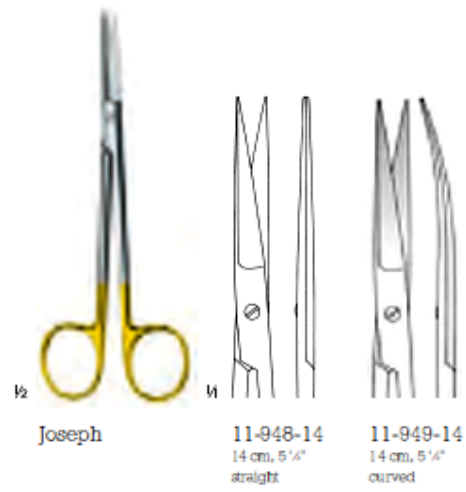









Scissors
Dissecting Scissors, Delicate Dissecting Scissors,

11

							
Mayo-Lexer	11-953-16	Metzenbaum	11-954-14	11-955-14	11-960-18	11-961-18	
	16 cm, 6 1/4"		14 cm, 5 1/4"	14 cm, 5 1/4"	18 cm, 7"	18 cm, 7"	
	curved,		straight, delicate	curved, delicate	straight, delicate	curved, delicate	

					
Metzenbaum delicate	11-956-14	11-957-14	Par	11-959-11	11-959-15
	14 cm, 5 1/4"	14 cm, 5 1/4"		11.5 cm, 4 1/4"	15 cm, 5 1/4"
	straight, delicate	curved, delicate		curved	curved
	sharp/sharp	sharp/sharp			

Scissors
 Delicate Dissecting Scissors

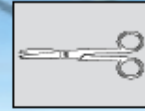

TCGOLD

11



Metzenbaum

11-961-20
 20 cm, 8"
 curved, delicate

11-961-23
 23 cm, 9"
 curved, delicate

11-961-28
 28 cm, 11"
 curved, delicate



Metzenbaum

11-962-18
 18 cm, 7"
 straight, delicate
 sharp/sharp

11-963-18
 18 cm, 7"
 curved, delicate
 sharp/sharp



Scissors
Dissecting Scissors, Delicate Dissecting Scissors

TCGOLD

11

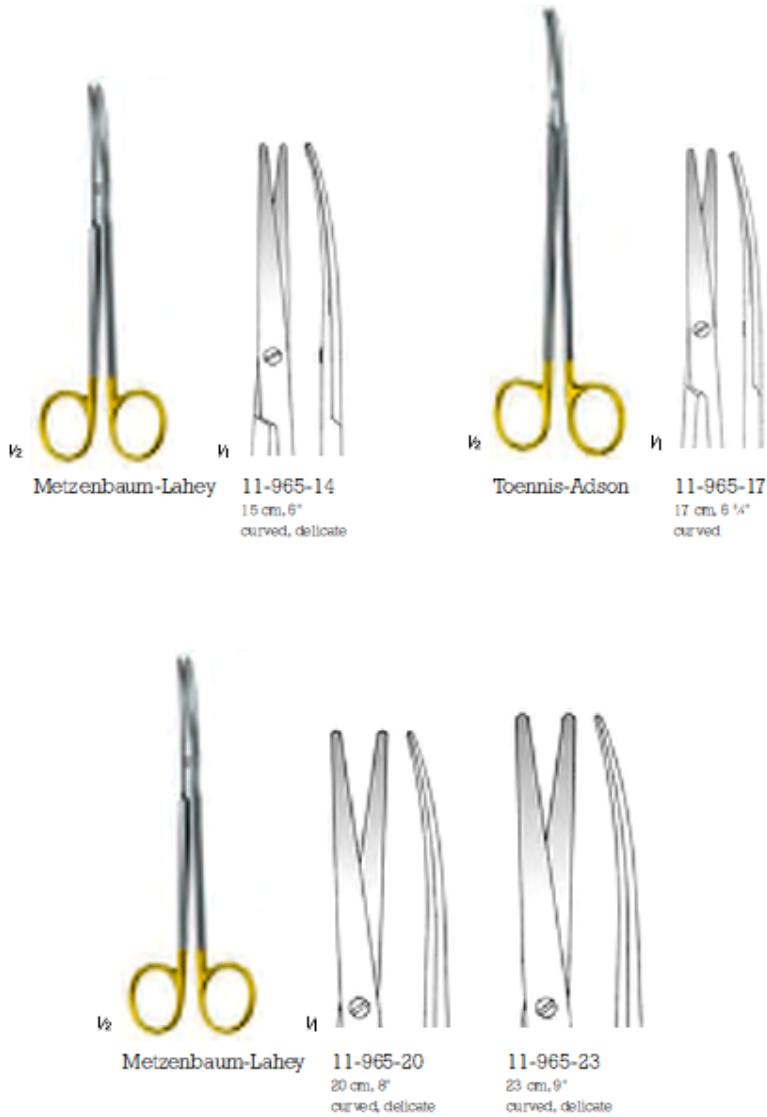

PRIMAX 
German Surgical Instruments Since 1956

ELMED 
Serving the Medical Profession Since 1956

Scissors 
 Face-Lift Scissors



TCGOLD

11



Gorney



11-970-19
 19.5 cm, 7 1/4"
 straight, serrated



11-970-23
 23 cm, 9"
 straight, serrated



Rees



11-973-17
 17 cm, 6 1/4"
 curved, serrated

For more face-lift scissors,
 see chapter 28



TCGOLD

11



Scissors
 Dissecting Scissors



TCGOLD

11

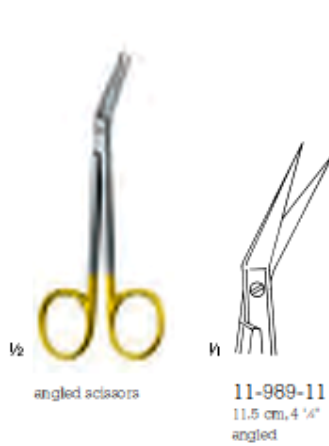



TCGOLD

11

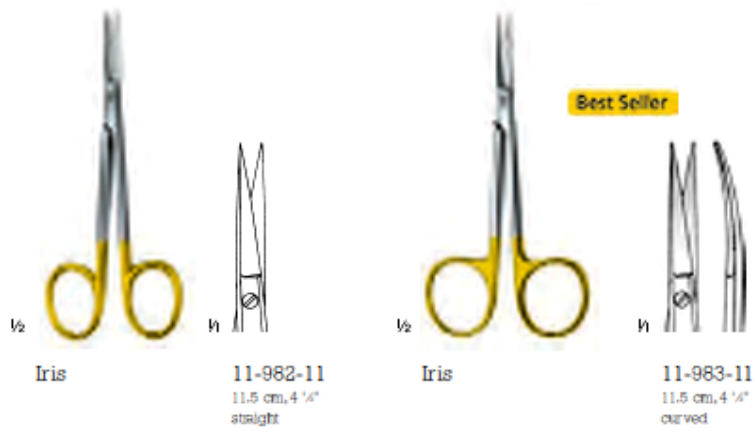

Scissors
 Tonsil And Gum Scissors, Gum Scissors



TCGOLD

11



1/2

Dean
 gun and tonsil scissors



1/4

Best Seller

11-994-17
 17 cm, 6 1/4"
 serrated



1/2

Locklin
 gun scissors



1/4

Best Seller

11-997-16
 16 cm, 6 1/4"
 angled, open shank,
 serrated



1/2

Locklin
 gum scissors

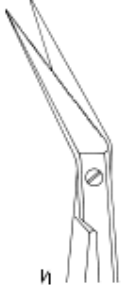

1/4

11-999-16
 16 cm, 6 1/4"
 angled, serrated,



Wire Instruments
Wire Scissors

11



1/2
BeeBee
wire scissors



1/1
11-874-10
10 cm, 4"
straight



11-875-10
10 cm, 4"
curved



11-879-12
12 cm, 4 1/4"
curved,
serrated



1/2
wire scissors

Best Seller



1/1
11-865-12
12.5 cm, 5"
angled
serrated

PRIMAX 
German Surgical Instruments Since 1956

ELMED 
Serving the Medical Profession Since 1956

Wire Instruments
Wire Scissors



TCGOLD

11



universal



11-995-12
12 cm, 4 1/4"
angled, serrated



Smith

Best Seller

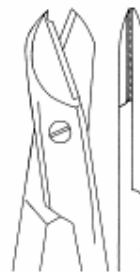

11-996-16
16 cm, 6 1/4"
with notch, serrated



11



1/2
Smith
 wire scissors, serrated
 cuts up to 1.00 mm wire



1/4
 00-100-98
 16 cm, 6 1/4"
 serrated



Wire Instruments
Arch Bar Cutters, Wire Cutters



1/2
arch bar cutters



W
01-006-05
14 cm, 5 1/2"



1/2
ETM
wire cutters,
cuts through 22 GA, # 7001

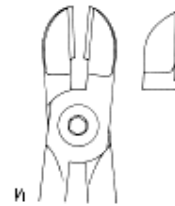

W
01-006-00
11.5 cm, 4 1/2"
wire cutter

12

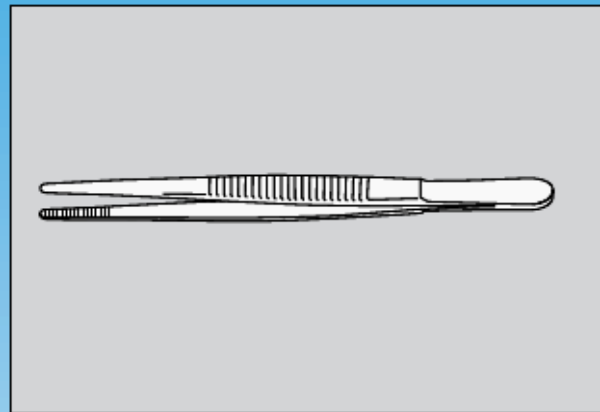

Forceps



Forceps
Tissue Forceps, Dressing Forceps

TCGOLD

12



1/2

Bonney



H

12-228-17
17 cm, 6 1/4"
normal profile
dressing



12-230-17
17 cm, 6 1/4"
normal profile
tissue



1/2

Gerald



H

12-232-17
17 cm, 6 1/4"
normal profile
dressing



12-234-17
17 cm, 6 1/4"
normal profile
tissue



1/2

Gerald
tissue



H

96-120-63
18 cm, 7"
normal profile



1/2

Gillies
tissue



H

12-236-15
15 cm, 6"
mini profile



1/2

McIndoe
dressing



H

12-238-15
15 cm, 6"
mini profile

for definition of normal, mini, micro, smooth jaws see page V

Forceps
Tissue Forceps, Dressing Forceps



TCGOLD

	<p>12-240-16 16 cm, 6 1/4"</p>	<p>12-240-18 18 cm, 7"</p>		<p>12-244-12 12 cm, 4 1/4" normal profile teeth</p>		<p>12-246-12 12 cm, 4 1/4" mini profile</p>	<p>12</p>
<p>1/2</p> <p>Semken tissue ⊗ 1:2</p>	<p>12-242-16 16 cm, 6 1/4" normal profile</p>	<p>12-242-18 18 cm, 7"</p>	<p>1/2</p> <p>Adson-Brown tissue ⊗ 4:4</p>	<p>1/2</p> <p>Micro-Adson tissue ⊗ 1:2</p>	<p>1/2</p> <p>12-246-15 15 cm, 6" mini profile</p>		
	<p>96-121-19 15 cm, 6" normal profile teeth ⊗ 4:4</p>		<p>12-250-12 12 cm, 4 1/4" normal profile dressing</p>	<p>12-250-15 15 cm, 6" normal profile dressing</p>		<p>12-254-17 18 cm, 7" normal profile</p>	
<p>1/2</p> <p>Adson-Brown tissue</p>	<p>1/2</p>	<p>1/2</p> <p>Adson</p>	<p>12-252-12 12 cm, 4 1/4" normal profile tissue ⊗ 1:2</p>	<p>12-252-15 15 cm, 6" normal profile tissue ⊗ 1:2</p>	<p>1/2</p> <p>Cushing dressing</p>	<p>1/2</p>	



Forceps
Dressing Forceps, Tissue Forceps

12

TC60LD



12-255-18
18 cm, 7"
angled
normal profile

1/2
Cushing
dressing



1/2
Potts-Smith
dressing



12-258-15
15 cm, 6"



12-258-16
18 cm, 7"



12-258-20
20 cm, 8"
normal profile



12-258-23
23 cm, 9"



12-258-25
25 cm, 10"



12-256-18
18 cm, 7"
normal profile

1/2
Cushing-Taylor
dressing



1/2
Oehler
tissue



12-260-14
14 cm, 5 1/4"



12-260-16
16 cm, 6 1/4"



12-260-18
18 cm, 7"



12-260-20
20 cm, 8"
normal profile



12-260-25
25 cm, 10"













Forceps
Dressing Forceps

12



- | | | | | |
|---|---|---|---|---|
|  |  |  |  |  |
| 12-100-10
10.5 cm, 4 1/4" | 12-100-11
11 cm, 4 1/4" | 12-100-13
13 cm, 5" | 12-100-14
14 cm, 5 1/4" | 12-100-16
16 cm, 6" |
|  |  |  |  | |
| 12-100-18
18 cm, 7" | 12-100-20
20 cm, 8" | 12-100-25
25 cm, 10" | 12-100-30
30 cm, 12" | |

Forceps
Dressing Forceps



12



1/2

serrated, delicate

M



12-120-11
 11 cm, 4 1/4"



12-120-13
 13 cm, 5"



12-120-14
 14 cm, 5 1/4"

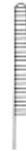

12-120-16
 16 cm, 6"

M



12-120-18
 18 cm, 7"

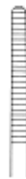

12-120-20
 20 cm, 8"



12-120-25
 25 cm, 10"





12-120-30
 30 cm, 12"



Forceps
Dressing Forceps, Tissue Forceps

12

Best Seller

12-166-12
12 cm, 4 1/4"



Adson Mini
dressing

12-168-12 12 cm, 4 1/4"
aerated

12-168-15 15 cm, 6"
aerated

Adson
dressing







12-368-12 12 cm, 4 1/4"



12-368-15 15 cm, 6"

Adson
tissue

 1:2

12-400-12 12 cm, 4 1/4"

Adson-Brown
tissue

 4:4



12-402-12 12 cm, 4 1/4"

Salyer-Adson
Mini
tissue

 1:2

Forceps
 Tissue Forceps, Dressing Forceps



12

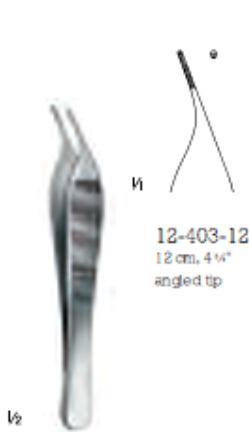

12-403-12
 12 cm, 4 1/4"
 angled tip

Adson Micro
 tissue
 1:2

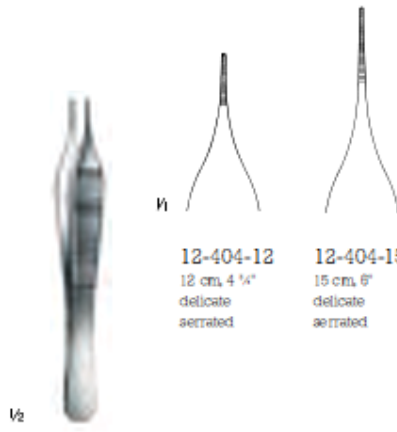

12-404-12
 12 cm, 4 1/4"
 delicate
 serrated

12-404-15
 15 cm, 6"
 delicate
 serrated

Adson Mini
 dressing

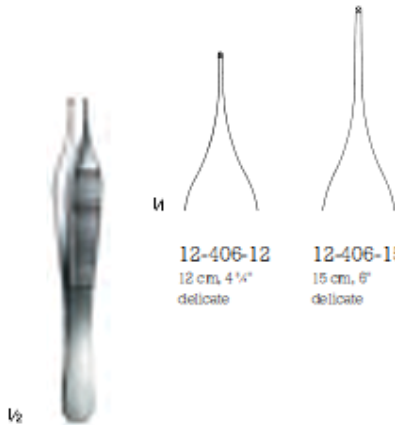

12-406-12
 12 cm, 4 1/4"
 delicate

12-406-15
 15 cm, 6"
 delicate

Adson Micro
 tissue
 1:2



Forceps
Dressing Forceps

12

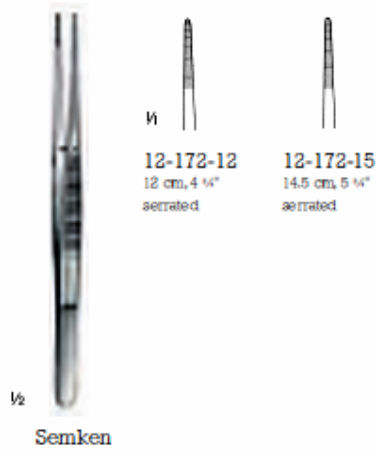
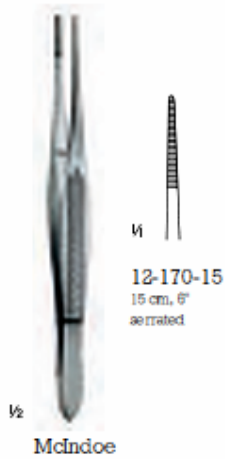

Forceps
Micro Dressing Forceps, Dressing Forceps



	<p>12-184-06 15.5 cm, 6" 0.6 mm tip serrated</p> <p>12-184-08 15.5 cm, 6" 0.8 mm tip serrated</p>		<p>12-186-18 18 cm, 7" straight, serrated</p> <p>12-187-18 18 cm, 7" curved, serrated</p>	<p>12</p>
<p>Turner micro dressing</p>	<p>Gerald dressing</p>			
	<p>12-188-17 17 cm, 6 1/4" straight, serrated</p> <p>12-189-17 17.5 cm, 7" curved, serrated</p>		<p>12-192-18 18 cm, 7" serrated</p> <p>12-192-21 21 cm, 8 1/4" serrated</p> <p>12-192-25 25 cm, 10" serrated</p>	
<p>Cushing dressing</p>	<p>Potts-Smith dressing</p>			

ELMED 
Serving the Medical Profession Since 1955

PRIMAX 
German Surgical Instruments Since 1955



Forceps
Atraumatic Forceps







12

 **Titanium**



1/2

DeBakey
atraumatic teeth

					
12-282-16 16 cm, 6 1/4" 1.5 mm tip	12-282-20 20 cm, 8" 1.5 mm tip	12-282-24 24 cm, 9 1/4" 1.5 mm tip	12-284-16 16 cm, 6 1/4" 1.8 mm tip	12-284-20 20 cm, 8" 1.8 mm tip	12-284-24 24 cm, 9 1/4" 1.8 mm tip









Forceps
Tissue Forceps





1/2

 1:2







M				
	12-301-10 10.5 cm, 4 1/4"	12-301-11 11 cm, 4 3/8"	12-301-13 13 cm, 5"	12-301-14 14.5 cm, 5 7/8"
				
	12-301-16 16 cm, 6 3/8"	12-301-18 18 cm, 7"	12-301-20 20 cm, 8"	12-301-25 25 cm, 10"

12



1/2

 2:3

M						
	12-302-11 11.5 cm, 4 5/8"	12-302-13 13 cm, 5"	12-302-14 14.5 cm, 5 7/8"	12-302-16 16 cm, 6 3/8"	12-302-18 18 cm, 7"	12-302-20 20 cm, 8"



Forceps
Tissue Forceps

12

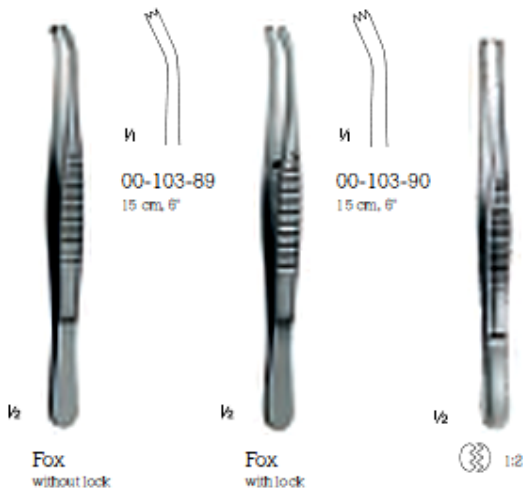
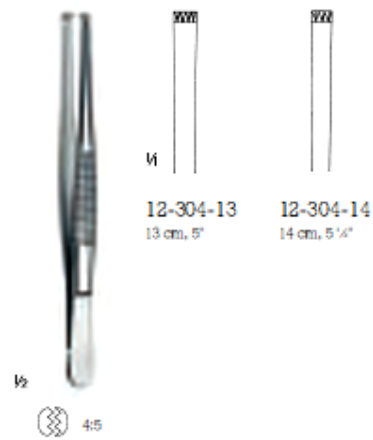
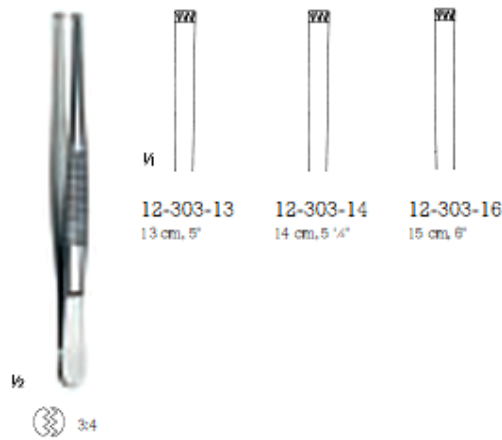

Forceps
Tissue Forceps

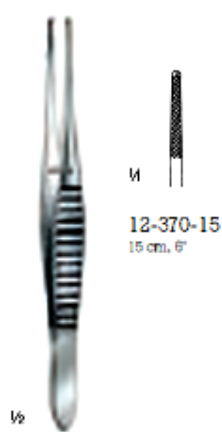

12-370-15
15 cm, 6"

1/2

Gillies



1:2



12-372-12
12 cm, 4 3/4"

1/2

Semken



1:2

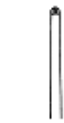

12-372-15
15 cm, 6"



96-121-25
15 cm, 6"

1/2

Brown
tissue



9:9

12



12-374-17
17.5 cm, 7"

1/2

Taylor



1:2



12-380-17
18.5 cm, 7 1/4"
with dissector end

1/2

Taylor



1:2



12-383-17
17.5 cm, 7"
with dissector end

1/2

Taylor
bayonet





















1:2



Forceps
Tissue Forceps, Insulated Forceps

12

	<p>  12-384-06 15 cm, 6" 0.6 mm tip  12-384-08 15 cm, 6" 0.8 mm tip  12-384-10 15 cm, 6" 1.0 mm tip </p>		<p>  12-386-17 17.5 cm, 7" straight  12-387-17 17 cm, 6 1/4" curved </p>		<p>  12-388-17 17 cm, 6 1/4" </p>
		Best Seller			
<p>Turner tissue</p>  1:2		<p>Gerald tissue</p>  1:2		<p>Cushing tissue</p>  1:2	
	<p>  12-392-18 18 cm, 7"  12-392-21 21 cm, 8 1/4"  12-392-25 25 cm, 10" </p>		<p>  12-394-20 20 cm, 8" for coagulation </p>		
<p>Potts-Smith tissue</p>  1:2		<p>Rees insulated forceps</p>			

Forceps
Jeweler Type Forceps



12

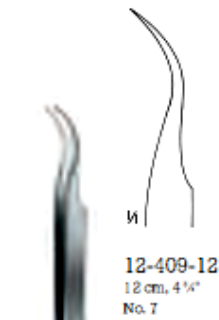

1/2
 Jewelers

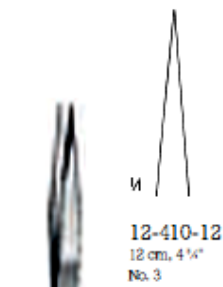

1/2
 Jewelers

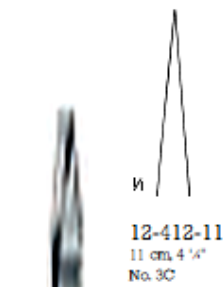

1/2
 Jewelers

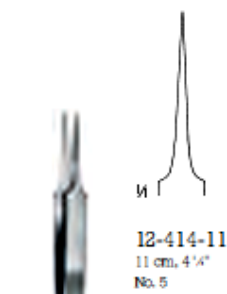

1/2
 Jewelers

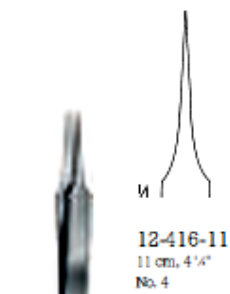

1/2
 Jewelers

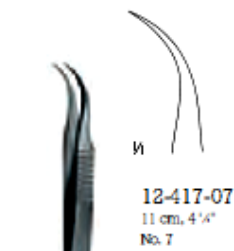

1/2
 Micro Jewelers



Forceps
Micro Jeweler Type Forceps

12

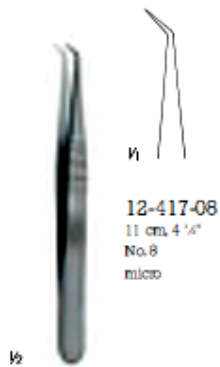

12-417-08
11 cm, 4 1/4"
No. 8
micro

1/2

Micro Jewelers

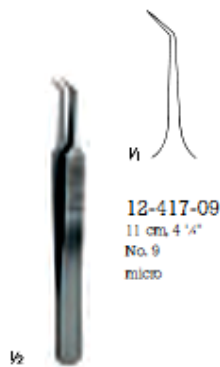

12-417-09
11 cm, 4 1/4"
No. 9
micro

1/2

Micro Jewelers

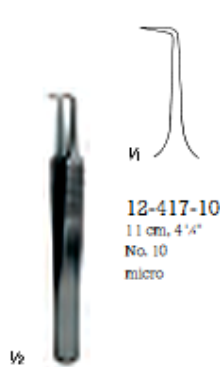

12-417-10
11 cm, 4 1/4"
No. 10
micro

1/2

Micro Jewelers



12-418-01
11 cm, 4 1/4"
No. 7A
micro

1/2

Micro Jewelers



12-418-02
13.5 cm, 5 1/4"
No. 3L
micro

1/2

Micro Jewelers

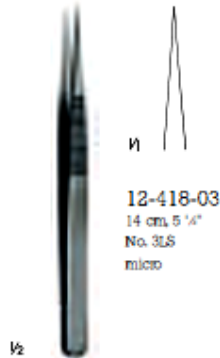

12-418-03
14 cm, 5 1/4"
No. 3LS
micro

1/2

Micro Jewelers

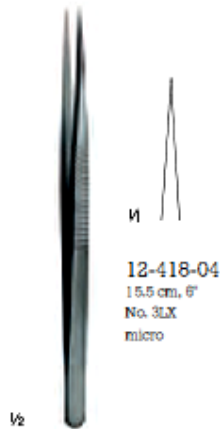

12-418-04
15.5 cm, 6"
No. 3LX
micro

1/2

Micro Jewelers



12-418-05
13 cm, 5 1/4"
No. 8L
micro

1/2

Micro Jewelers

Forceps
Tissue Forceps



1/2

Russian

Best Seller



12-420-15
15 cm, 6"



12-420-20
20 cm, 8"



12-420-25
25 cm, 10"

12



1/2

Ferris-Smith



12-431-18
18 cm, 7"



1:2



12-432-18
18 cm, 7"



2:3



1/2

Bonney



12-451-18
18 cm, 7"



1:2



Forceps
Dressing Forceps

12



1/2

Singley-Tuttle



1/2

12-460-23
23 cm, 9"



1/2

Eye Dressing
delicate



1/2

12-502-10
10.5 cm, 4 1/4"
straight
serrated



12-503-10
10.5 cm, 4 1/4"
half curved
serrated



90°

12-505-10
9.5 cm, 3 1/4"
full curved
serrated

Forceps
Tissue Forceps



12



Iris
 delicate



12-512-10
 10.5 cm, 4 1/4"
 straight



12-513-10
 10.5 cm, 4 1/4"
 half curved



12-515-10
 10.5 cm, 4 1/4"
 full curved





Forceps
Micro Dressing Forceps, Micro Tissue Forceps, Splinter Forceps

12



1/2

micro forceps



12-566-18
18 cm, 7"
6.0 x 0.7 mm tip
dressing

knurled handle



12-571-18
18 cm, 7"
6.0 x 0.7 mm tip
tissue

knurled handle



1:2



1/2

micro forceps



12-580-18
18 cm, 7"
6.0 x 0.8 mm tip
dressing

knurled handle,
blue



12-585-18
18 cm, 7"
6.0 x 0.8 mm tip
tissue

knurled handle,
blue



1:2

 Titanium



1/2

splinter forceps



12-600-12
12.5 cm, 5"
smooth, straight
sharp tips



1/2

splinter forceps



12-601-12
12.5 cm, 5"
smooth, curved
sharp tips



1/2

splinter forceps



12-604-12
12.5 cm, 5"
serrated, straight
sharp tips



1/2

splinter forceps



12-605-12
12.5 cm, 5"
serrated, curved
sharp tips

Forceps
Tying Forceps, Cilia Forceps



12



12-616-16
 15.5 cm, 6"
 smooth

1/2

micro tying forceps



12-664-08
 8.5 cm, 3 1/4"
 straight
 smooth

1/2

Littauer
 cilia



12-666-09
 9 cm, 3 1/4"
 angled
 serrated

1/2

cilia



12-674-09
 9 cm, 3 1/4"
 straight
 tapered tip

1/2

Douglas
 cilia



12-676-09
 9 cm, 3 1/4"
 straight
 serrated

1/2

Douglas
 cilia



12-680-09
 9 cm, 3 1/4"
 smooth

1/2

Beer
 cilia



Forceps
Splinter Forceps

12

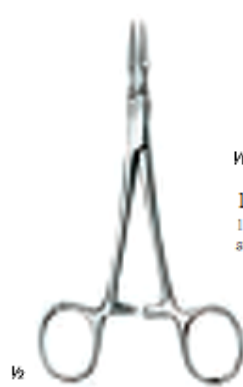

Stieglitz (Archer)



12-720-13
14 cm, 5 1/4"
straight



12-721-13
14 cm, 5 1/4"
angled



Peet



12-725-11
11 cm, 4 1/4"
angled



Ralk



12-740-15
15 cm, 6"
straight



12-741-15
15 cm, 6"
angled

13

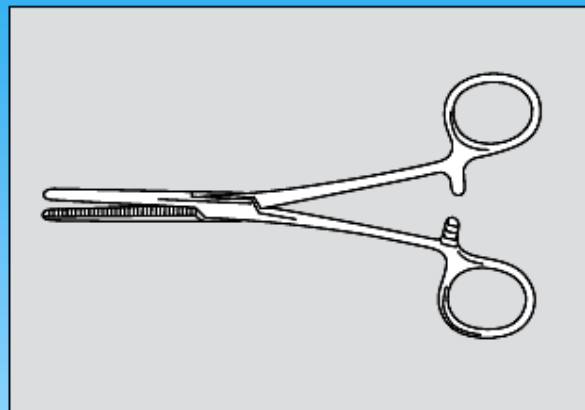

Artery Forceps



Artery Forceps
Bulldog Clamps

13



1/2

Dieffenbach



1/4

13-114-03
3.5 cm, 1 1/4"
straight



13-114-05
5 cm, 2"
straight



13-115-03
3.5 cm, 1 1/4"
curved



13-115-05
5 cm, 2"
curved

Artery Forceps
Bulldog Clamps



Diethrich



	13-120-10	13-120-12	13-121-08	13-121-10	13-121-12
	straight	straight	angled	angled	angled
Length	5 cm, 2"	6 cm, 2 1/4"	5 cm, 2"	5 cm, 2"	6 cm, 2 1/4"
Jaw length	12 mm	20 mm	8 mm	12 mm	20 mm
Closing pressure	50 gr.	50 gr.	50 gr.	50 gr.	50 gr.
Weight	3 gr.	3 gr.	3 gr.	3 gr.	3 gr.

13



DeBakey-Diethrich



	13-122-10	13-122-14	13-122-20	13-123-10	13-123-14	13-123-20
	straight	straight	straight	angled	angled	angled
Length	4.5 cm, 1 1/4"	5 cm, 2"	6 cm, 2 1/4"	3.5 cm, 1 1/8"	4.5 cm, 1 1/4"	6 cm, 2 1/4"
Jaw length	10 mm	14 mm	20 mm	10 mm	14 mm	20 mm
Closing pressure	180 gr.	180 gr.	180 gr.	180 gr.	180 gr.	180 gr.
Weight	3 gr.	3 gr.	3 gr.	3 gr.	3 gr.	3 gr.



Artery Forceps
Hemostatic Forceps, Face-lift Forceps

13



1/2

Pennington
hemostatic forceps



1/4

13-280-15
15.5 cm, 6"



13-280-20
21 cm, 8 1/4"



1/2

Martel
face-lift forceps



1/4

13-290-14
14 cm, 5 1/2"

Artery Forceps
Hemostatic Forceps

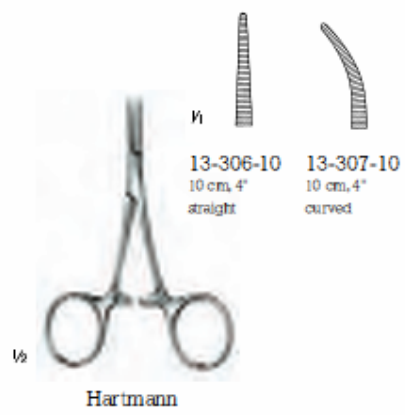

13

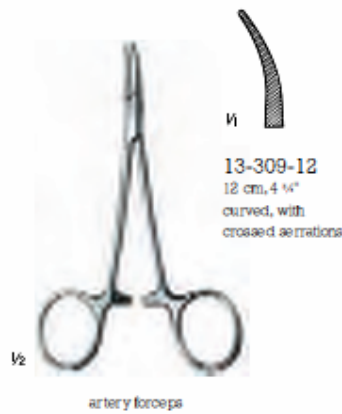

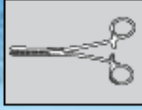

Artery Forceps
Hemostatic Forceps

13

Best Seller

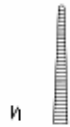

H

13-310-12
12 cm, 4 1/4"
straight



13-310-14
14 cm, 5 1/2"
straight

Best Seller



13-311-12
12 cm, 4 1/4"
curved

Best Seller



13-311-14
14 cm, 5 1/2"
curved



1/2

Halsted Mosquito

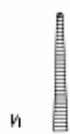

H

13-312-12
12.5 cm, 5"
straight
 1:2



13-312-14
14 cm, 5 1/2"
straight
 1:2



13-313-12
12.5 cm, 5"
curved
 1:2



13-313-14
14 cm, 5 1/2"
curved
 1:2

Artery Forceps
 Hemostatic Forceps



1/2

Jacobson Mosquito



1/4

13-314-01
 18 cm, 7"
 straight



13-314-02
 13 cm, 5"
 curved, delicate



13-314-03
 18 cm, 7"
 slightly curved



13-314-04
 18 cm, 7"
 fully curved



13-314-05
 13 cm, 5"
 straight, delicate











Artery Forceps
Hemostatic Forceps

13











1/2
Halsted Mosquito

- | | | | |
|---|---|---|---|
|  |  |  |  |
| h | | | |
| 13-316-18
18 cm, 7"
straight | 13-316-21
21 cm, 8 1/4"
straight | 13-317-18
18 cm, 7"
curved | 13-317-21
21 cm, 8 1/4"
curved |

- | | | | |
|---|---|---|---|
|  |  |  |  |
| h | | | |
| 13-320-10
10 cm, 4"
straight, delicate | 13-320-12
12.5 cm, 5"
straight, delicate | 13-321-10
10 cm, 4"
curved, delicate | 13-321-12
12.5 cm, 5"
curved, delicate |



1/2
Micro Mosquito

- | | | | |
|---|---|---|---|
|  |  |  |  |
| h | | | |
| 13-322-10
10 cm, 4"
straight | 13-322-12
12 cm, 4 1/4"
straight | 13-323-10
10 cm, 4"
curved | 13-323-12
12 cm, 4 1/4"
curved |
|  1:2 |  1:2 |  1:2 |  1:2 |

Artery Forceps
Hemostatic Forceps





13-324-14
 14 cm, 5 1/4"
 straight

1/2

Providence Hospital



13-325-14
 14 cm, 5 1/4"
 curved



13-326-15
 15 cm, 6"
 straight

1/2

Leriche



13-327-15
 15 cm, 6"
 curved

13



13-328-15
 15 cm, 6"
 straight

1/2

Leriche

 1:2



13-329-15
 15 cm, 6"
 curved



13-330-14
 14 cm, 5 1/4"
 straight

1/2

Kelly

Best Seller



13-331-14
 14 cm, 5 1/4"
 curved

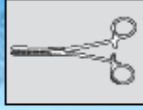

Artery Forceps
Hemostatic Forceps

13



Kelly-Rankin

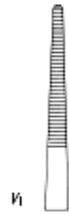

13-334-16
16 cm, 6 1/4"
straight



13-335-16
16 cm, 6 1/4"
curved



Obwegeser
also used for wire catching



13-337-13
13 cm, 5"

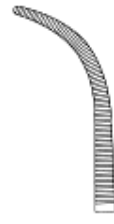

13-337-19
18 cm, 7"

Best Seller



Crile



13-340-14
14 cm, 5 1/2"
straight



13-341-14
14 cm, 5 1/2"
curved



13-342-14
14 cm, 5 1/2"
straight



13-343-14
14 cm, 5 1/2"
curved



1:2



1:2

Artery Forceps
Hemostatic Forceps

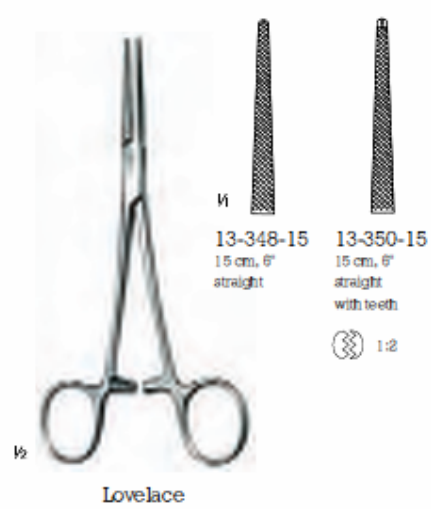
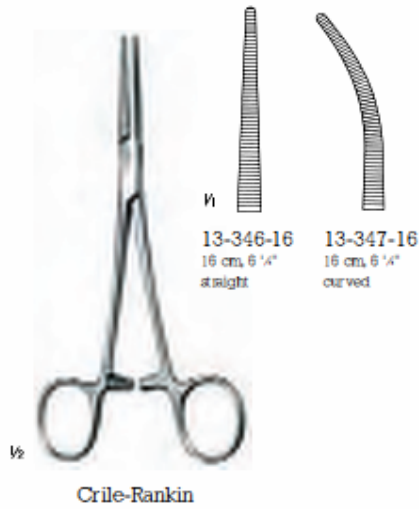

13

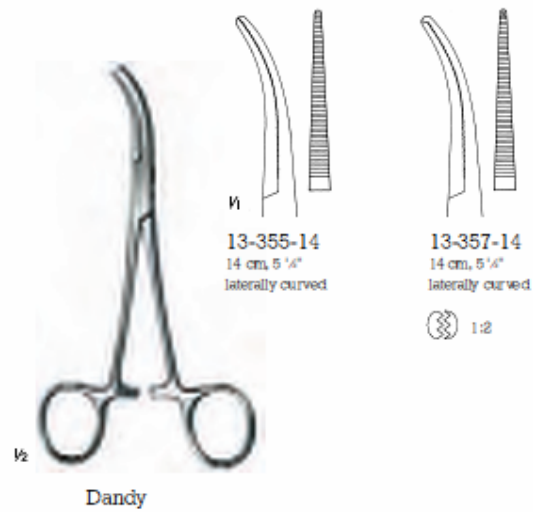

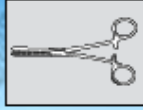

Artery Forceps
Hemostatic Forceps







13



**Artery Forceps
 Hemostatic Forceps**







Pean

					
13-374-13 13 cm, 5" straight	13-374-14 14 cm, 5 1/2" straight	13-374-16 16 cm, 6 1/4" straight	13-375-13 13 cm, 5" curved	13-375-14 14 cm, 5 1/2" curved	13-375-16 16 cm, 6 1/4" curved

13

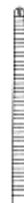

Kocher

					
13-384-13 13 cm, 5" straight delicate	13-384-14 14 cm, 5 1/2" straight delicate	13-384-16 16 cm, 6 1/4" straight delicate	13-385-13 13 cm, 5" curved delicate	13-385-14 14 cm, 5 1/2" curved delicate	13-385-16 16 cm, 6 1/4" curved delicate



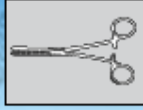









Artery Forceps
Hemostatic Forceps

13



1/2

Rochester-Pean

							
13-410-14	13-410-16	13-410-18	13-410-20	13-410-22	13-410-24	13-410-26	13-410-30
14 cm, 5 1/4"	16 cm, 6 1/4"	18 cm, 7"	20 cm, 8"	22.5 cm, 8 7/8"	24.5 cm, 9 7/8"	26 cm, 10 1/4"	30 cm, 12"
straight	straight	straight	straight	straight	straight	straight	straight

**Artery Forceps
 Hemostatic Forceps**



Best Seller

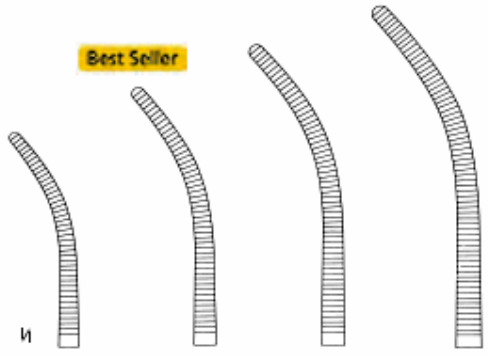

- h 13-411-14
14 cm, 5 1/4"
curved
- 13-411-16
16 cm, 6 1/4"
curved
- 13-411-18
18 cm, 7"
curved
- 13-411-20
20 cm, 8"
curved

13



h/2 **Rochester-Pean**

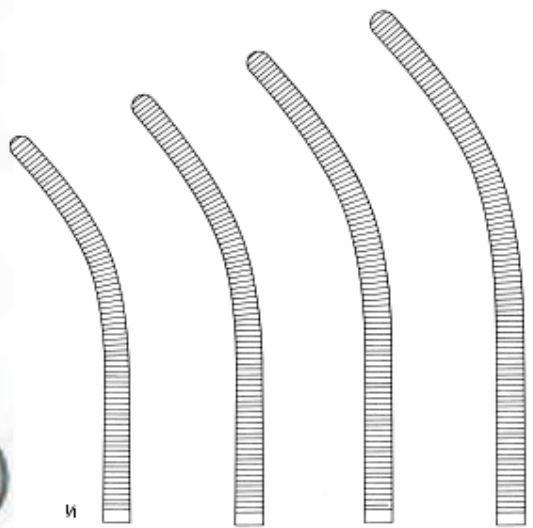



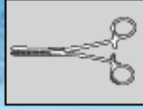

- h 13-411-22
22 cm, 8 1/4"
curved
- 13-411-24
24 cm, 9 1/4"
curved
- 13-411-26
26 cm, 10 1/4"
curved
- 13-411-30
30 cm, 12"
curved



Artery Forceps
Hemostatic Forceps



13

- | | | | |
|---|---|---|---|
|  |  |  |  |
| 13-414-14
14 cm, 5 1/4"
straight | 13-414-16
16 cm, 6 1/4"
straight | 13-414-18
18 cm, 7"
straight | 13-414-20
20 cm, 8"
straight |

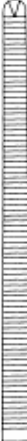
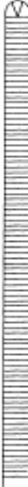

1/2

Ochsner
 1:2

- | | | | |
|---|---|---|---|
|  |  |  |  |
| 13-414-22
22 cm, 8 1/2"
straight | 13-414-24
24 cm, 9 1/2"
straight | 13-414-26
26 cm, 10 1/2"
straight | 13-414-30
30 cm, 12"
straight |

Artery Forceps
Hemostatic Forceps

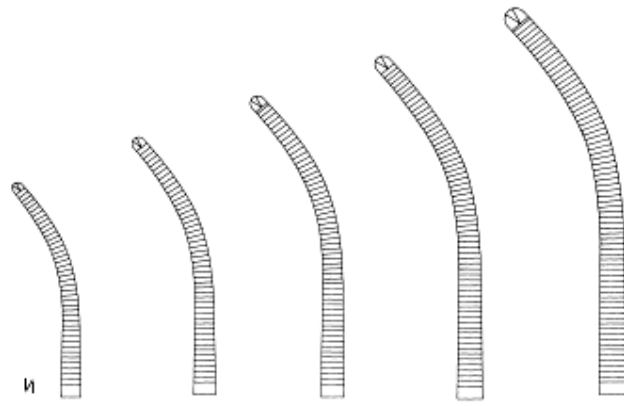

M

13-415-14
 14 cm, 5 1/4"
 curved

13-415-16
 16 cm, 6 1/4"
 curved

13-415-18
 18 cm, 7"
 curved

13-415-20
 20 cm, 8"
 curved

13-415-22
 22 cm, 8 1/2"
 curved

13



1/2

Ochsner

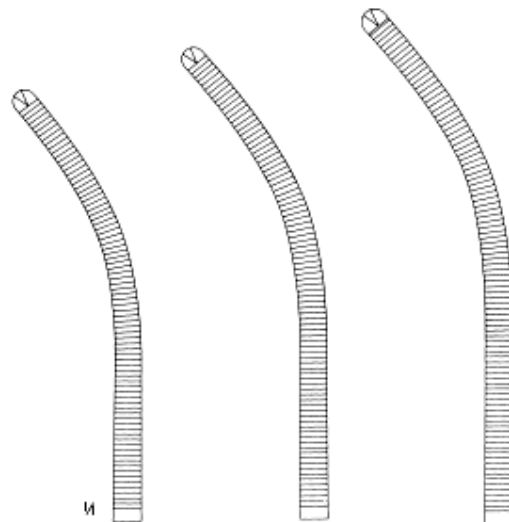

M

13-415-24
 24 cm, 9 1/4"
 curved

13-415-26
 25 cm, 10"
 curved

13-415-30
 30 cm, 12"
 curved

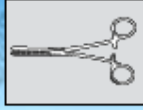

Artery Forceps
Dissecting And Ligature Forceps

13

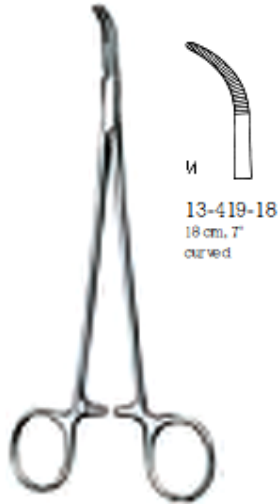

Baby-Mixter

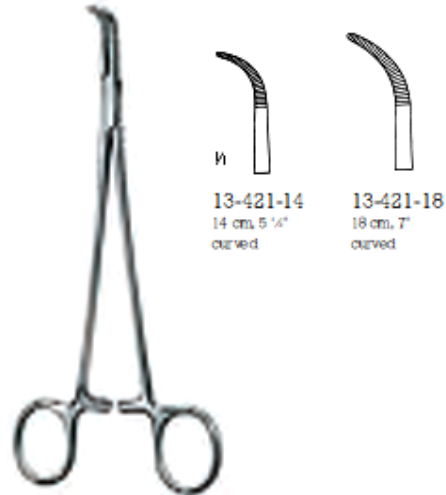

Baby-Adson

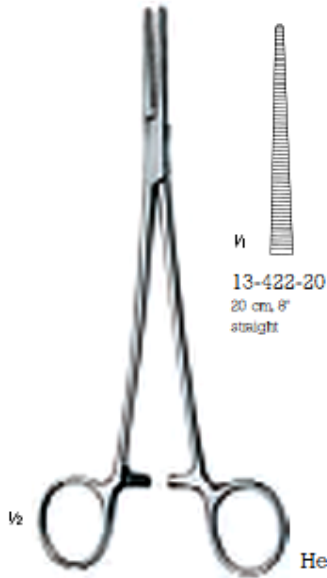

Heiss

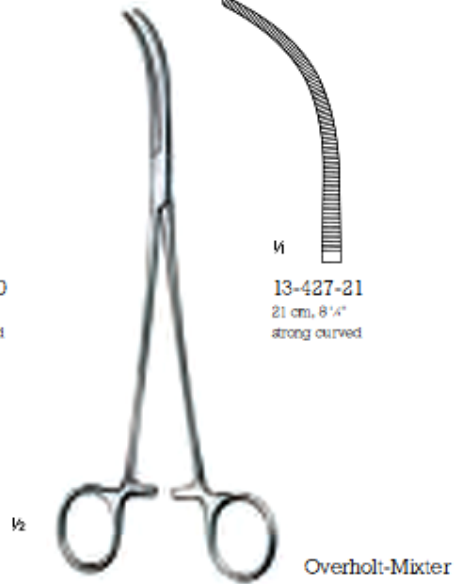
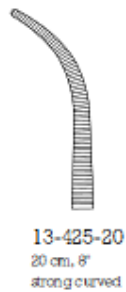
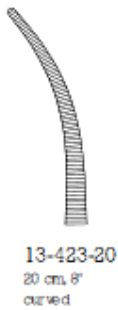

Overholt-Mixter

Also see chapter 39, tonsil forceps

Artery Forceps
Dissecting And Ligature Forceps



13



Craford

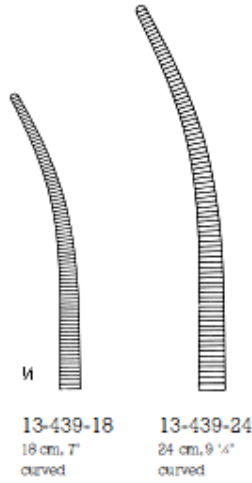

Gemini

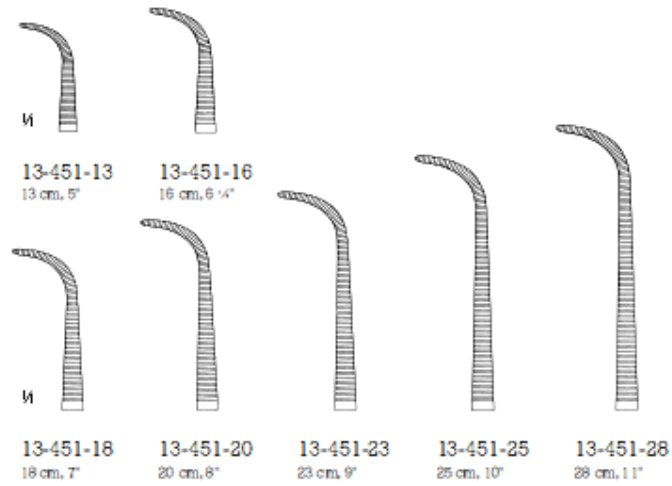

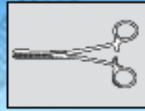

Artery Forceps
Dissecting And Ligature Forceps

13



1/2

Mini-Gemini



1/4

13-453-18
18 cm, 7"



13-453-22
22 cm, 8 1/2"



13-453-25
25 cm, 10"



13-453-28
28 cm, 11"



1/2

Baby Mixer



1/4

13-471-14
14 cm, 5 1/2"



1/2

Mixer

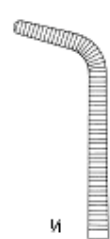

1/4

13-473-15
15.5 cm, 6"



13-473-19
18 cm, 7"

Artery Forceps
 Dissecting And Ligature Forceps

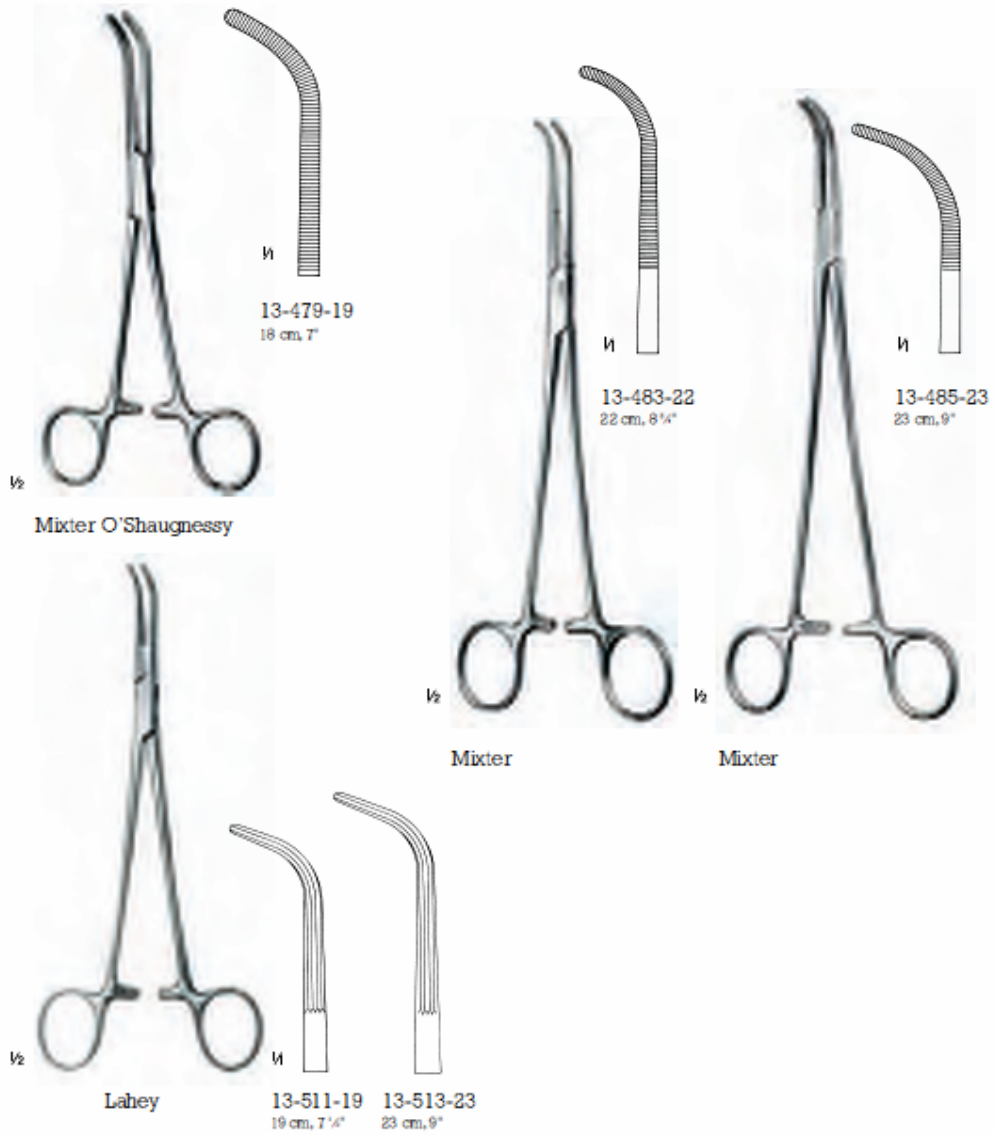

13

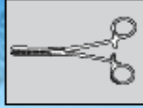

Artery Forceps
Dissecting And Ligature Forceps

13



13-577-19
19 cm, 7 1/4"
slight curved



13-577-22
22 cm, 8 1/4"
slight curved



13-577-24
24 cm, 9 1/4"
slight curved



13-579-19
19 cm, 7 1/4"
curved



13-579-22
22 cm, 8 1/4"
curved



13-579-24
24 cm, 9 1/4"
curved



13-581-19
19 cm, 7 1/4"
strong curved



13-581-22
22 cm, 8 1/4"
strong curved







13-581-24
24 cm, 9 1/4"
strong curved



1/2

Kelly



 1/2 Jones	<p>13-881-05 5.5 cm, 2 1/4"</p> <p>13-881-09 9 cm, 3 1/4"</p>	 1/2 Backhaus	<p>Best Seller 13-915-08 8 cm, 3 1/4"</p> <p>Best Seller 13-915-11 10.5 cm, 4 1/4"</p> <p>13-915-13 Best Seller 13 cm, 5"</p> <p>13-915-15 15 cm, 6"</p>	 1/2 Roeder	<p>13-917-13 13 cm, 5"</p> <p>13-917-15 15 cm, 6"</p>	 1/2 Lorna	<p> M</p> <p>13-919-10 10 cm, 4"</p> <p>13-919-13 13 cm, 5"</p> <p>fine serrated, wide jaw</p>	<div style="background-color: red; color: white; padding: 5px; width: 30px; height: 30px; display: flex; align-items: center; justify-content: center; margin: 0 auto;">13</div>
--	---	---	---	--	---	---	--	--

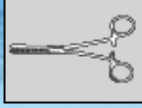

Artery Forceps
Towel Clamps

13



1/2

Tohoku



1/1

13-923-10
10 cm, 4"

13-923-13
13 cm, 5"

blunt



1/2

Peers-Bertram



1/1

13-923-14
14.5 cm, 5 1/2"

Artery Forceps
Tube Occluding Forceps



13-944-15
 15 cm, 6"



13-944-18
 18.5 cm, 7 1/4"



13-944-20
 20 cm, 8"

13

1/2

tube occluding forceps



13-946-15
 15 cm, 6"



13-946-18
 18 cm, 7"



13-946-20
 20 cm, 8"

1/2

tube occluding forceps
 with safety guard

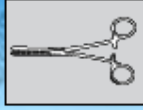

Artery Forceps
Sponge Forceps

13



1/2

Foerster



1/1

14-350-25
25 cm, 10"

smooth, straight



14-352-18
18 cm, 7"

14-352-25
25 cm, 10"

serrated, straight

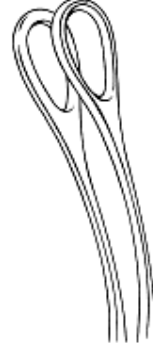

14-353-25
25 cm, 10"

smooth, curved

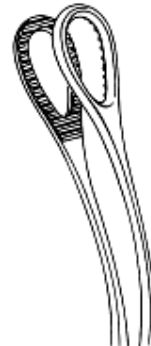

14-355-18
18 cm, 7"

14-355-25
25 cm, 10"

serrated, curved

15

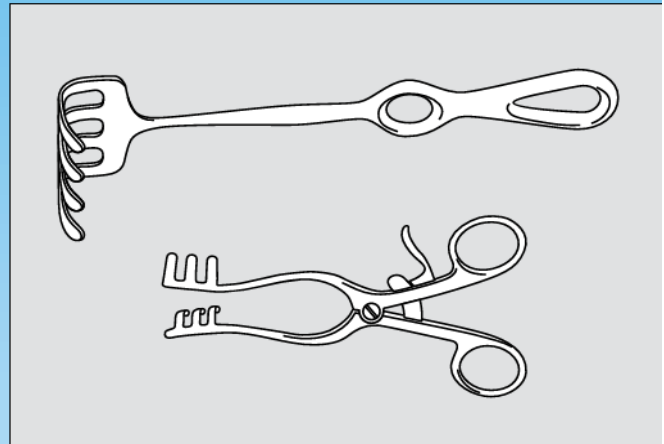

Retractors









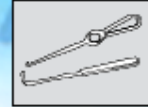

Retractors
Hooks, Saddle Hooks, Tendon Hooks, Rakes

15



 <p>00-101-19 16.5 cm, 6 1/4" Size 1</p>  <p>00-101-20 16.5 cm, 6 1/4" Size 2</p>  <p>00-101-21 16.5 cm, 6 1/4" Size 3</p>  <p>00-101-22 16.5 cm, 6 1/4" Size 4</p> <p>skin hook octagonal handle</p>	 <p>15-001-18 18.5 cm, 7" titanium handle</p>  <p>15-006-01 17 cm, 6 1/4" titanium handle</p>  <p>15-011-01 17 cm, 6 1/4" titanium handle</p> <p>Vickers skin hook</p>	 <p>15-006-01 17 cm, 6 1/4" titanium handle</p>  <p>15-011-01 17 cm, 6 1/4" titanium handle</p> <p>Vickers skin hook</p>	 <p>15-011-01 17 cm, 6 1/4" titanium handle</p>  <p>15-011-01 17 cm, 6 1/4" titanium handle</p> <p>Vickers tendon hook</p>	
 <p>15-021-02 16 cm, 6 1/4" titanium handle, two prongs, sharp</p>  <p>15-021-03 16 cm, 6 1/4" titanium handle, three prongs, sharp</p> <p>Vickers skin hook</p>	 <p>15-021-03 16 cm, 6 1/4" titanium handle, three prongs, sharp</p> <p>Vickers skin rake</p>	 <p>15-030-12 14.5 cm, 5 1/4" titanium handle, 12 mm blade</p>  <p>15-030-14 14.5 cm, 5 1/4" titanium handle, 14 mm blade</p>  <p>15-030-16 14.5 cm, 5 1/4" titanium handle, 16 mm blade</p> <p>Vickers saddle hook</p>	 <p>15-030-14 14.5 cm, 5 1/4" titanium handle, 14 mm blade</p>  <p>15-030-16 14.5 cm, 5 1/4" titanium handle, 16 mm blade</p> <p>Vickers saddle hook</p>	 <p>15-030-16 14.5 cm, 5 1/4" titanium handle, 16 mm blade</p> <p>Vickers saddle hook</p>

Retractors
 Micro Hooks, Skin Hooks, Double Hooks



							
	15-066-01 16 cm, 6 1/4" sharp	15-066-02 16 cm, 6 1/4" blunt		15-068-01 16 cm, 6 1/4" Size 1 sharp	15-068-02 16 cm, 6 1/4" Size 2 sharp	15-068-03 16 cm, 6 1/4" Size 3 sharp	15-068-04 16 cm, 6 1/4" Size 4 sharp
1/2			1/2				
Graefe micro hook			skin hook serrated handle				

15

		
15-070-16 16 cm, 6 1/4" sharp	15-072-01 16 cm, 6 1/4" small sharp	15-072-02 16 cm, 6 1/4" large sharp
1/2	1/2	
O'Connor skin hook	Guthrie double hook	

Also see chapter 34/35.



Retractors
Hooks, Rakes

15



finger retractor



15-074-01
16.5 cm, 6 1/4"
hook, sharp



15-074-02
16.5 cm, 6 1/4"
hook, sharp



15-074-03
16.5 cm, 6 1/4"
rake, sharp



15-074-04
16.5 cm, 6 1/4"
rake, sharp



finger retractor



15-075-01
16.5 cm, 6 1/4"
hook, blunt



15-075-02
16.5 cm, 6 1/4"
hook, blunt



15-075-03
16.5 cm, 6 1/4"
rake, blunt



15-075-04
16.5 cm, 6 1/4"
rake, blunt



flexible neck
retractor



15-078-02
16 cm, 6 1/4"
hook, sharp



15-078-03
16 cm, 6 1/4"
rake, sharp



15-078-04
16 cm, 6 1/4"
rake, sharp



15-079-02
16 cm, 6 1/4"
hook, blunt



15-079-03
16 cm, 6 1/4"
rake, blunt



15-079-04
16 cm, 6 1/4"
rake, blunt



finger retractor



15-086-04
16.5 cm, 6 1/4"
rake, sharp



15-087-04
16.5 cm, 6 1/4"
rake, blunt

Retractors
Micro Retractors, Saddle Hooks,
Soft Tissue Retractors



15





Retractors
Hooks, Retractors, Rakes

15



15-099-16
16 cm, 6 1/4"
14 mm x 8 mm blade,
two prongs, blunt

finger retractor



15-100-01
16 cm, 6 1/4"
hook, sharp

finger retractor



15-100-02
16.5 cm, 6 1/2"
hook, sharp



15-100-03
16.5 cm, 6 1/2"
rake, sharp



15-100-04
16 cm, 6 1/4"
rake, sharp

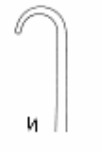

15-101-01
16.5 cm, 6 1/2"
hook, blunt

finger retractor



15-101-02
16 cm, 6 1/4"
hook, blunt



15-101-03
16.5 cm, 6 1/2"
rake, blunt



15-101-04
16 cm, 6 1/4"
rake, blunt



Meyering
retractor



15-151-01
17.5 cm, 7"
Fig. 1, blunt



15-151-02
17.5 cm, 7"
Fig. 2, serrated



15-151-03
17.5 cm, 7"
Fig. 3, serrated



15-151-04
17.5 cm, 7"
Fig. 4, blunt



15-151-05
17.5 cm, 7"
Fig. 5, saddle shaped



15-151-06
17.5 cm, 7"
Fig. 6, sharp

Retractors
Retractors



1/2
Senn-Green
 retractor



15-161-01
 15 cm, 6"
 20 mm x 6 mm



15-161-02
 15 cm, 6"
 10 mm x 6 mm



1/2
Ragnell-Davis
 retractor



8 x 4 mm
 15-164-14
 14 cm, 5 1/4"



15 x 5.5 mm

15



1/2
Crile
 00-101-03
 retractor, double-ended
 size 1



blade 17 x 5 mm
 blade 21 x 7.5 mm



1/2
Senn-Mueller
 retractor



15-166-16
 16 cm, 6 1/4"
 sharp

blade 20 mm x 7 mm



15-167-16
 16 cm, 6 1/4"
 blunt

blade 20 mm x 7 mm



Retractors
Retractors

15

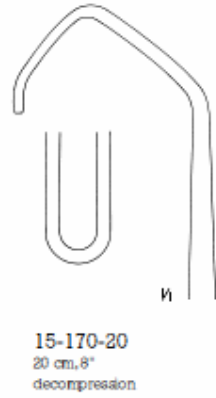

Retractors
Saddle Hooks















 1/2 Cushing	  15-171-08 20 cm, 8" 8 mm blade	  15-171-10 20 cm, 8" 10 mm blade	 1/2 Cushing	  15-172-08 24 cm, 9 1/4" 8 mm blade	  15-172-10 24 cm, 9 1/4" 10 mm blade
	  15-171-12 20 cm, 8" 12 mm blade	  15-171-14 20 cm, 8" 14 mm blade		  15-172-12 24 cm, 9 1/4" 12 mm blade	  15-172-14 24 cm, 9 1/4" 14 mm blade
	  15-171-16 20 cm, 8" 16 mm blade	  15-171-18 20 cm, 8" 18 mm blade		  15-172-16 24 cm, 9 1/4" 16 mm blade	  15-172-18 24 cm, 9 1/4" 18 mm blade



Retractors
Saddle Hooks



15

			
			
	15-174-08 24 cm, 9 1/4" 8 mm blade	15-174-11 24 cm, 9 1/4" 11 mm blade	15-174-15 24 cm, 9 1/4" 15 mm blade
			
1/2 Gil-Vernet malleable shaft			
	15-174-17 24 cm, 9 1/4" 17 mm blade	15-174-20 24 cm, 9 1/4" 20 mm blade	15-174-23 24 cm, 9 1/4" 23 mm blade

Also see chapter 34/35.

Retractors
Vein Hooks, Retractors, Hooks

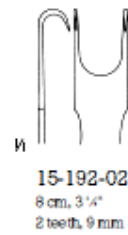
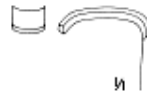
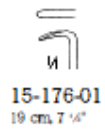



Retractors
Hooks, Rakes

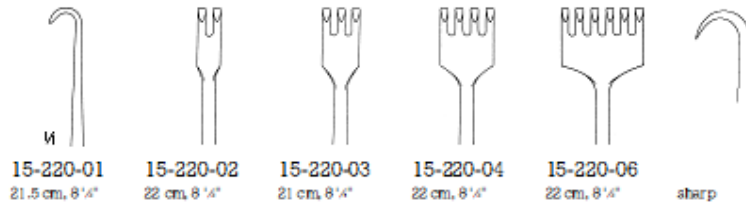

15-220-01 21.5 cm, 8 1/4" 15-220-02 22 cm, 8 1/4" 15-220-03 21 cm, 8 1/4" 15-220-04 22 cm, 8 1/4" 15-220-06 22 cm, 8 1/4" sharp

15

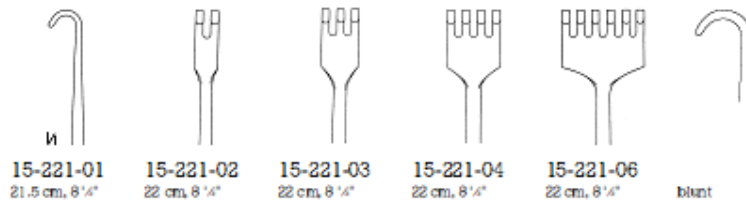

15-221-01 21.5 cm, 8 1/4" 15-221-02 22 cm, 8 1/4" 15-221-03 22 cm, 8 1/4" 15-221-04 22 cm, 8 1/4" 15-221-06 22 cm, 8 1/4" blunt



1/2
Volkmann

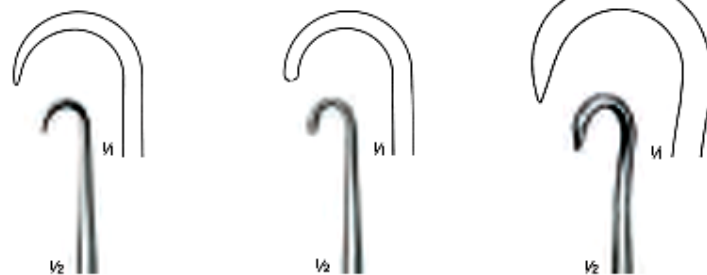

15-230-01 21.5 cm, 8 1/4" sharp 15-231-01 21.5 cm, 8 1/4" blunt 15-232-01 20.5 cm, 8" sharp

Retractors
Retractors

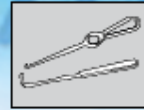

15-281-04
23.5 cm, 9 1/4"
40 x 40 mm



15-283-05
23.5 cm, 9 1/4"
45 x 40 mm



15-287-06
23.5 cm, 9 1/4"
50 x 60 mm



15-289-07
23.5 cm, 9 1/4"
70 x 70 mm



1/2

Israel



Retractors
Retractors

15



15-293-01
21 cm, 8 1/4", 30 x 11 mm blade



15-293-02
21 cm, 8 1/4", 30 x 14 mm blade

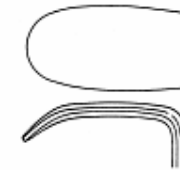

15-293-03
21 cm, 8 1/4", 30 x 16 mm blade



15-293-04
21 cm, 8 1/4", 40 x 11 mm blade



1/2

Langenbeck



1/2

15-291-05
23 cm, 9", 50 x 11 mm blade



1/2

Langenbeck



1/2

15-293-05
21 cm, 8 1/4", 50 x 11 mm blade

Retractors
Retractors



$\frac{1}{2}$
Kocher-Langenbeck
 curved down

15-317-01
 21.5 cm, 8 $\frac{1}{4}$ "
 25 x 6 mm blade

15-317-02
 21.5 cm, 8 $\frac{1}{4}$ "
 35 x 8 mm blade

15-317-03
 21.5 cm, 8 $\frac{1}{4}$ "
 35 x 11 mm blade

15-317-04
 21.5 cm, 8 $\frac{1}{4}$ "
 35 x 15 mm blade

15-317-05
 21.5 cm, 8 $\frac{1}{4}$ "
 40 x 11 mm blade

15-317-06
 21.5 cm, 8 $\frac{1}{4}$ "
 55 x 11 mm blade

15-317-07
 21.5 cm, 8 $\frac{1}{4}$ "
 70 x 14 mm blade

15-317-08
 21.5 cm, 8 $\frac{1}{4}$ "
 80 x 12 mm blade

15-317-09
 21.5 cm, 8 $\frac{1}{4}$ "
 80 x 16 mm blade

15

Curved tip style available,
 see page 414.



Retractors
Retractors

15



И

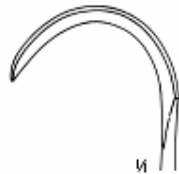

И



И



И

15-351-01
23 cm, 9"
40 x 10 mm blade



15-351-02
23 cm, 9"
40 x 15 mm blade



15-351-03
23 cm, 9"
40 x 20 mm blade



И

15-361-01
21.5 cm, 8 1/4"
14 x 17 mm blade



15-361-02
21.5 cm, 8 1/4"
20 x 22 mm blade

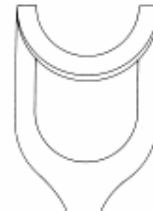

15-361-03
21.5 cm, 8 1/4"
26 x 30 mm blade



И

15-325-01
21.5 cm, 8 1/4"
19 x 12 mm



1/2

Kocher **15-325-02**
21.5 cm, 8 1/4"
21 x 14 mm blade



1/2

Kocher **15-351-03**
23 cm, 9"
40 x 20 mm blade



1/2

Middeldorpf **15-361-03**
21.5 cm, 8 1/4"
26 x 30 mm blade

Retractors
Retractors

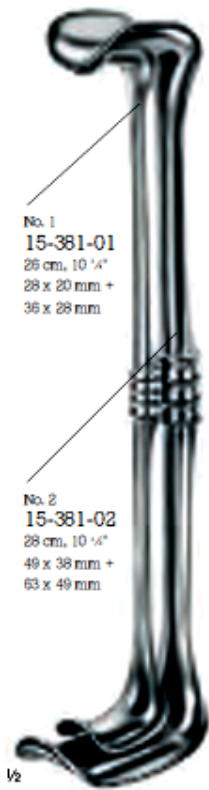

No. 1
15-381-01
 26 cm, 10 1/4"
 28 x 20 mm +
 36 x 28 mm

No. 2
15-381-02
 28 cm, 10 3/4"
 49 x 38 mm +
 63 x 49 mm

1/2

Richardson-Eastman



1/2

Richardson



15-391-01
 24 cm, 9 1/4"
 28.5 x 22 mm blade

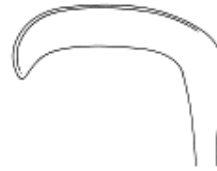

15-391-02
 24 cm, 9 1/4"
 36 x 28 mm blade

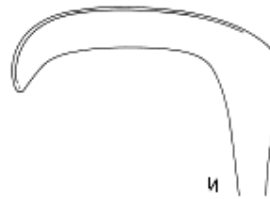

15-391-03
 24 cm, 9 1/4"
 44 x 38 mm blade

1/4

15



Retractors
Retractors

15



1/2

Richardson
appendectomy

15-395-24
23 cm, 9"
53 x 22 mm



1/2

Kelly

15-397-26
26 cm, 10 1/4"
70 x 50 mm

Retractors
Retractors



$\frac{1}{2}$
Deaver
15-591-01
18 cm, 7"
19 mm



$\frac{1}{2}$
Deaver
15-591-02
21.5 cm, 8 $\frac{1}{4}$ "
22 mm

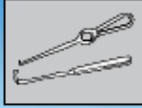

Retractors
Retractors

15



1/2

Roux

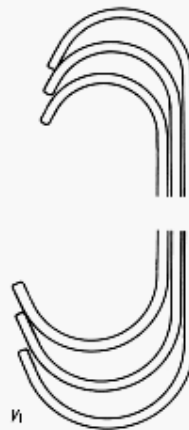

1/2

15-655-01
14 cm, 5 1/4"
No. 1

15-655-02
15 cm, 6"
No. 2

15-655-03
17 cm, 6 1/4"
No. 3



1/2

Roux "S"

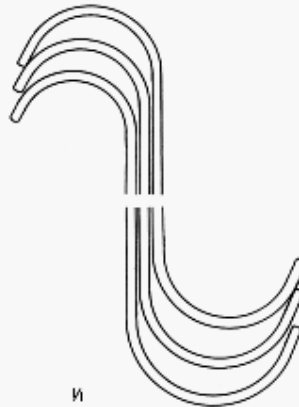

1/2

00-105-02
14 cm, 5 1/4"
No. 1

00-105-03
15 cm, 6"
No. 2

00-105-04
16.5 cm, 6 1/4"
No. 3

Retractors
Retractors



Farabeuf

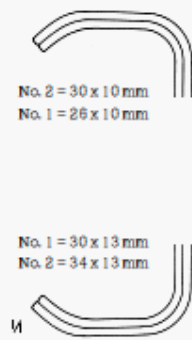

No. 2 = 30 x 10 mm
 No. 1 = 26 x 10 mm

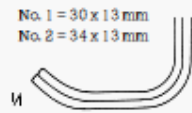

No. 1 = 30 x 13 mm
 No. 2 = 34 x 13 mm

15-663-00
 12 cm, 4 1/4"
 No. 1-2



Farabeuf

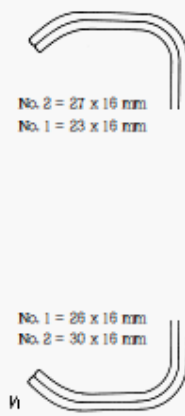

No. 2 = 27 x 16 mm
 No. 1 = 23 x 16 mm

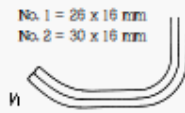

No. 1 = 26 x 16 mm
 No. 2 = 30 x 16 mm

15-665-00
 15 cm, 6"
 No. 1-2



Roux-Mini



15-667-06
 14 cm, 5 1/4"



Baby-Roux

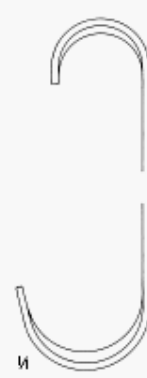

15-669-13
 13 cm, 5"

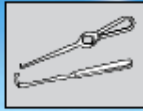

Retractors
Retractors

15



Parker

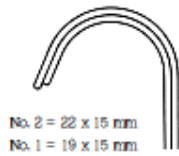

No. 2 = 22 x 15 mm
No. 1 = 19 x 15 mm

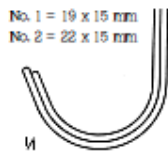

No. 1 = 19 x 15 mm
No. 2 = 22 x 15 mm

15-673-01
13.5 cm, 5 1/4"
No. 1-2



Parker

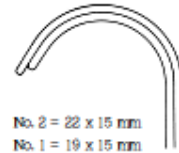

No. 2 = 22 x 15 mm
No. 1 = 19 x 15 mm

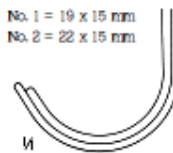

No. 1 = 19 x 15 mm
No. 2 = 22 x 15 mm

15-673-02
18 cm, 7"
No. 1-2



Parker-Mott

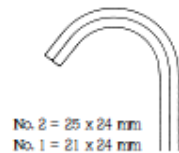

No. 2 = 25 x 24 mm
No. 1 = 21 x 24 mm

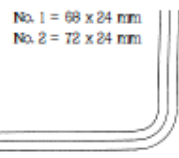

No. 1 = 18 x 24 mm
No. 2 = 22 x 24 mm

15-675-00
16 cm, 6 1/4"
No. 1-2

Retractors
Retractors

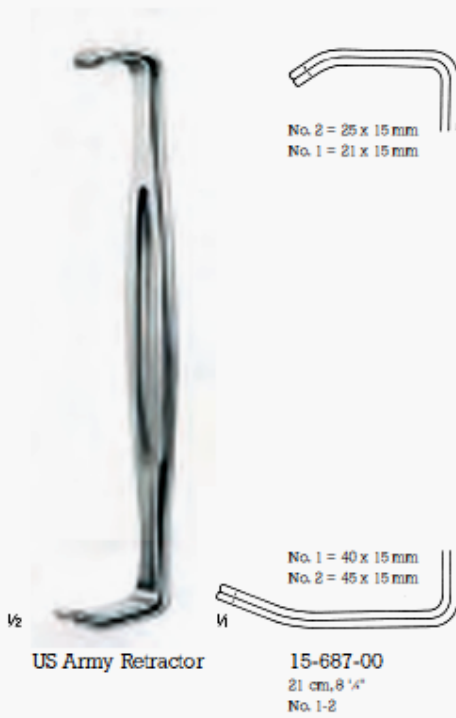

15



Retractors
Spring Retractors, Self-retaining Retractors

15



Finsen



15-700-05
5 cm, 2"
sharp



15-701-05
5 cm, 2"
blunt



15-702-07
7 cm, 2 1/4"
sharp



15-703-07
7 cm, 2 1/4"
blunt



00-101-69
8.5 cm, 3 1/4"
spring retractor

00-101-70
11 cm, 4 1/4"
spring retractor



Alm



15-714-07
7 cm, 2 1/4"
sharp



15-714-10
10 cm, 4"
sharp



15-715-07
7 cm, 2 1/4"
blunt



15-715-10
10 cm, 4"
blunt



Walton



15-717-10
10 cm, 4"
blunt

Retractors
Self-retaining Retractors



Jansen
 with adjusting screw

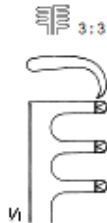

15-720-10
 10 cm, 4"
 sharp



15-723-10
 10 cm, 4"
 blunt



Scalp-Contour
 with ratchet

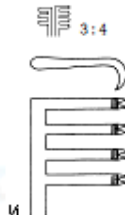

15-725-14
 14 cm, 5 1/4"
 sharp



15-727-14
 14 cm, 5 1/4"
 blunt



Anderson-Adson
 with ratchet



15-732-20
 19.5 cm, 7 1/4"
 sharp

15

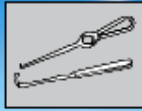

Retractors
Self-retaining Retractors

15



Weillaner
with satchet

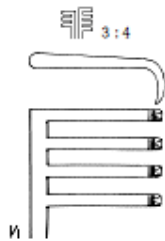

15-734-20
20 cm, 8"
sharp

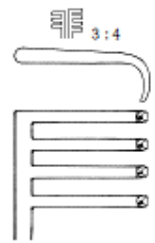

15-735-20
20 cm, 8"
blunt



Weillaner
with ratchet



15-748-10
10.5 cm, 4 1/4"
sharp

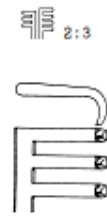

15-749-10
10.5 cm, 4 1/4"
blunt

Retractors
Self-retaining Retractors



Weidener
with ratchet



15-750-13
13 cm, 5"
sharp



15-750-16
16 cm, 6 1/4"
sharp



15-751-13
13 cm, 5"
blunt



15-751-16
16 cm, 6 1/4"
blunt

15



Weidener-Wulstein
with ratchet



15-752-13
13 cm, 5"
sharp

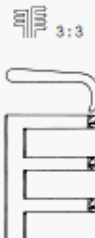

15-753-13
13 cm, 5"
blunt



Mollison
with ratchet



15-754-15
15 cm, 6"
sharp



Retractors
Self-retaining Retractors

15

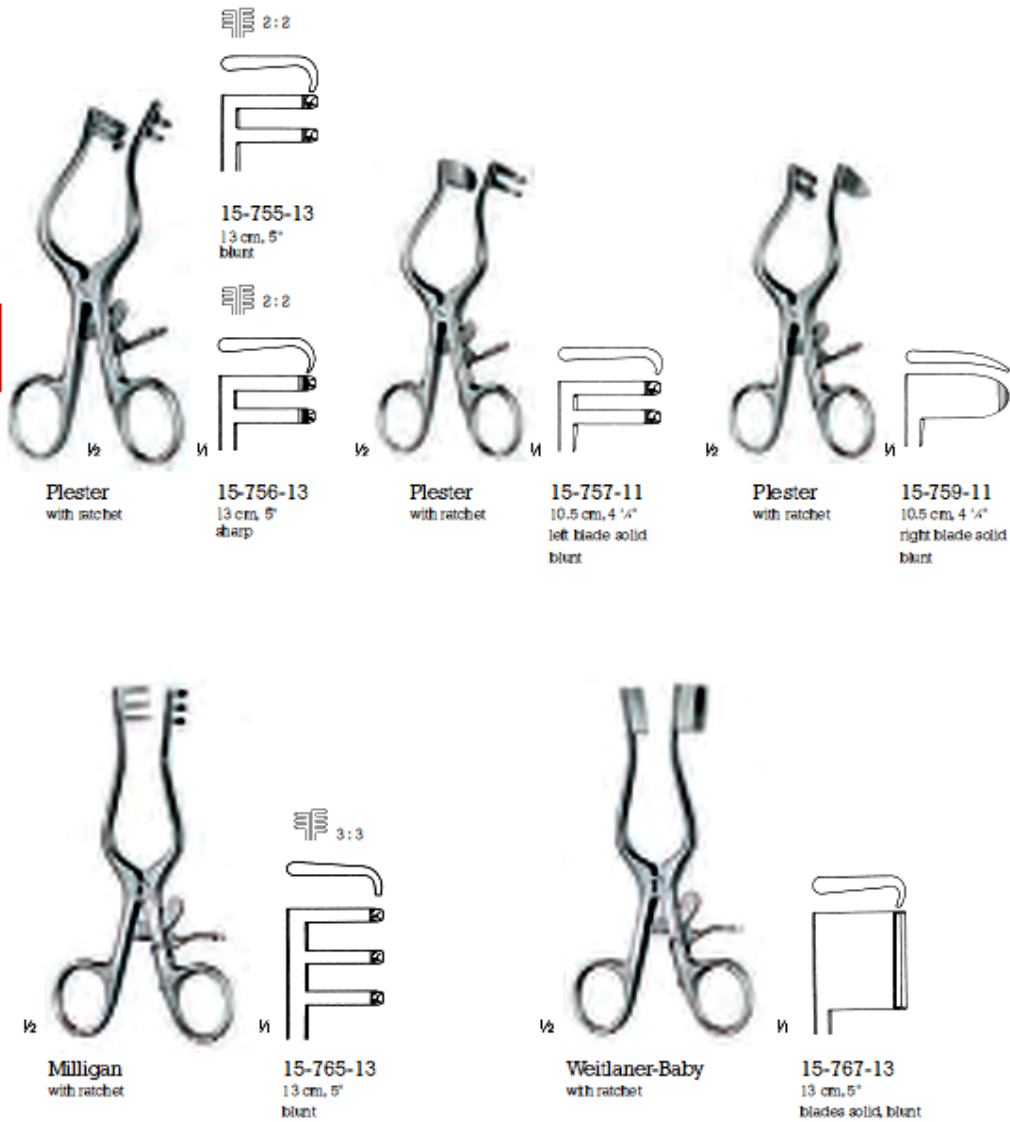

Retractors
Self-retaining Retractors



 3:4



Adson
 with ratchet



15-770-13
 26 cm, 10 1/4"
 blade 13 mm, sharp



15-771-13
 26 cm, 10 1/4"
 blade 13 mm, blunt



15-770-16
 26 cm, 10 1/4"
 blade 16 mm, sharp

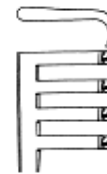

15-771-16
 26 cm, 10 1/4"
 blade 16 mm, blunt



15-770-20
 26 cm, 10 1/4"
 blade 20 mm, sharp



15-771-20
 26 cm, 10 1/4"
 blade 20 mm, blunt

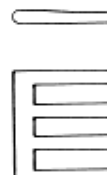

15-770-26
 26 cm, 10 1/4"
 blade 26 mm, sharp



15-771-26
 26 cm, 10 1/4"
 blade 26 mm, blunt



Retractors
Self-retaining Retractors

15

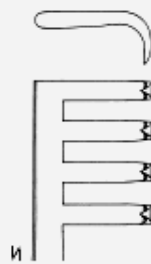

4:4

15-776-31
31 cm, 12 1/4"
sharp

1/2

Beckmann
with ratchet

PRIMAX 
German Surgical Instruments Since 1956

ELMED 
Serving the Medical Profession Since 1965

Retractors
Self-retaining Retractors



Adison
with ratchet

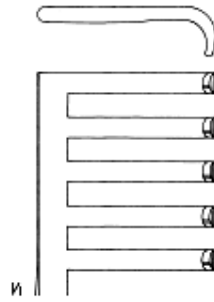

 4:5

15-777-32
32 cm, 12 1/4"
blunt

15



Retractors
Self-retaining Retractors

Vickers Low-Profile Universal Hand and Carpal Tunnel Spreader

- automatic adaption to the size of the wound
- long, blunt blades provide a secure retention outside the operating field avoiding surgical obstruction



15

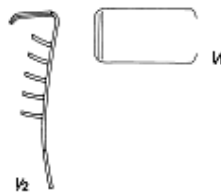

15-792-01
central blades
10 x 18 mm



Vickers Low-Profile 15-792-00
7.5 cm, 3"
complete with central blade
ref. 15-792-01

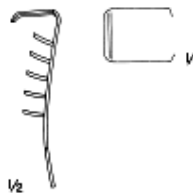

15-792-02
central blades
12 x 10 mm

Vickers Low-Profile Hand and Forearm Retractor

- automatic adaption to the size of the wound
- long, blunt blades provide a secure retention of the spreader
- large and comfortable ring handles outside the operating field avoiding surgical obstruction

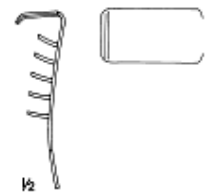

15-793-01
central blades
10 x 18 mm



Vickers Low-Profile 15-793-00
9 cm, 3 1/4"
complete with central blade
ref. 15-792-01

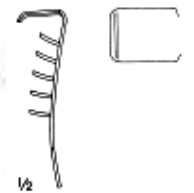

15-792-02
central blades
12 x 10 mm

Retractors
Self-retaining Retractors



Vickers Low-Profile Spreader for Trigger Finger and small cut

- automatic adaption to the size of the wound
- long, blunt blades provide secure placement of the spreader
- large and comfortable ring handles outside the operating field avoiding surgical obstruction
- optimized retention of fat tissue of tendon sheath



Vickers Finger Wound Spreader

- can be placed in any position on the thumb and fingers
- automatic adaption to the size of the wound
- embraces the finger completely
- long and blunt hook ends also for thin skin



15

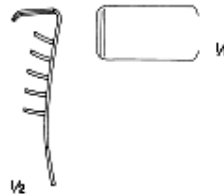

15-792-01
central blade
10 x 18 mm



Vickers Low-Profile
15-794-00
7.5 cm, 3"
complete with central blade
ref. 15-792-01

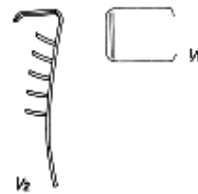

15-792-02
central blade
12 x 10 mm



Vickers
15-798-01
5 cm, 2"
blunt, ring model, for
thumb and fingers



Retractors
Self-retaining Retractors

15



Gelpi
with ratchet



15-802-13
13 cm, 5"



Gelpi
with ratchet



15-802-18
18 cm, 7"



Gelpi
with ratchet
and bell stops

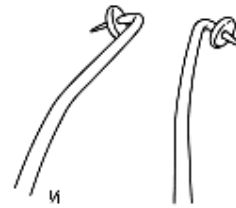

15-804-18
18 cm, 7"

Retractors
Abdominal Retractors



spreading 90 mm
 center blade 24 x 20 mm

Balfour-Baby 15-850-00
 12.5 cm, 5"



Balfour
 central blade

- | | | | |
|------------|------------|------------|------------|
| 15-859-01 | 15-859-02 | 15-859-05 | 15-859-06 |
| 45 x 80 mm | 68 x 85 mm | 68 x 85 mm | 40 x 68 mm |



spreading 200 mm
 lateral blades 100 x 35 mm
 center blade 100 x 60 mm

Balfour 15-856-00
 20 cm, 8"

15



Retractors
Abdominal Retractors

15



with two pairs of each lateral blades ref. 15-860-06 and ref. 15-860-08 and one center blade ref. 15-859-05, 68 x 85 mm

Balfour 15-860-00



1/2
15-860-06

fenestrated blades
60 mm deep (pair)



1/2
15-860-08

fenestrated blades
80 mm deep (pair)

Retractors
Malleable Ribbon Retractors

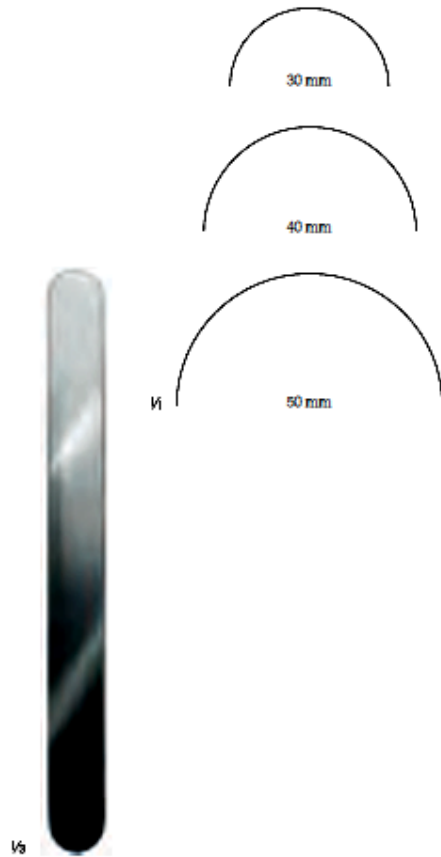

15-963-01	33 cm, 13"	30 mm
15-963-02	33 cm, 13"	40 mm
15-963-03	33 cm, 13"	50 mm

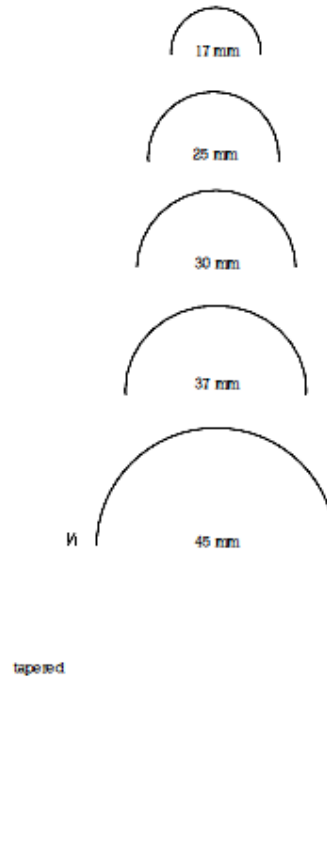

Haberer

15-971-00	20 cm, 8"	17 - 25 mm
15-971-01	28 cm, 11"	25 - 30 mm
15-971-02	30 cm, 11 1/4"	37 - 45 mm

15



Retractors
Malleable Ribbon Retractors

15

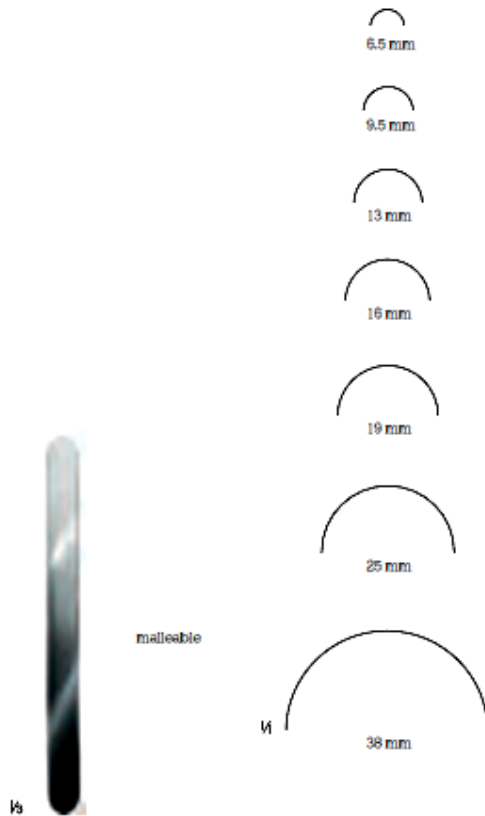

Martin

15-975-06	20 cm, 8"	6.5 mm
15-975-09	20 cm, 8"	9.5 mm
15-975-13	20 cm, 8"	13 mm
15-975-16	20 cm, 8"	16 mm
15-975-19	20 cm, 8"	19 mm
15-975-25	20 cm, 8"	25 mm
15-975-38	20 cm, 8"	38 mm

16

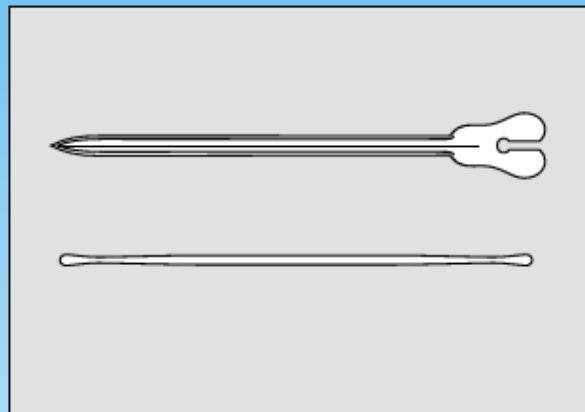



Probes



Probes
Probes

16





M 

2 mm Ø

- 16-100-11 = 11.5 cm, 4 1/2"
- 16-100-13 = 13 cm, 5"
- 16-100-14 = 14 cm, 5 1/2"
- 16-100-16 = 16 cm, 6 1/4"
- 16-100-18 = 18 cm, 7"
- 16-100-20 = 20 cm, 8"

1/2



M 

1 mm Ø

- 16-102-11 = 11.5 cm, 4 1/2"
- 16-102-13 = 13 cm, 5"
- 16-102-14 = 14.5 cm, 5 1/2"
- 16-102-16 = 16 cm, 6 1/4"
- 16-102-18 = 18 cm, 7"
- 16-102-20 = 20 cm, 8"

1/2



2 mm Ø

- 16-108-13 = 13 cm, 5"
- 16-108-14 = 14.5 cm, 5 1/2"
- 16-108-16 = 16 cm, 6 1/4"

M 

1/2

with eye

Probes
 Grooved Directors, Cotton Applicators

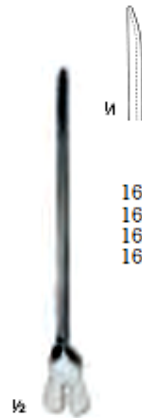

- 16-160-11 = 11.5 cm, 4 1/4"
- 16-160-13 = 13 cm, 5"
- 16-160-14 = 14.5 cm, 5 1/4"
- 16-160-16 = 16 cm, 6 1/4"

grooved directors



- 16-170-13 = 13 cm, 5"
- 16-170-14 = 14.5 cm, 5 1/4"
- 16-170-16 = 16 cm, 6 1/4"
- 16-170-18 = 18 cm, 7"

grooved directors

16



- 16-420-12 = 12 cm, 4 1/4" 0.9 mm Ø
- 16-420-14 = 14 cm, 5 1/4" 0.9 mm Ø
- 16-420-16 = 16 cm, 6 1/4" 1.1 mm Ø

Farrell
 cotton applicator

For more probes see chapter 35.

18

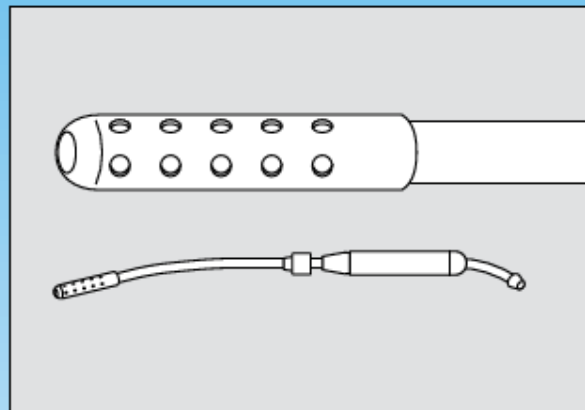

Suction Tubes, Cannulas

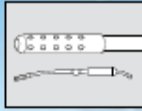

Suction Tubes, Cannulas
Suction Cannulas

18



1/2

Baron
00-100-95 14cm, 5 1/4" 1.0mm Ø 3 French
00-100-96 14cm, 5 1/4" 1.7mm Ø 5 French
00-100-97 14cm, 5 1/4" 2.3mm Ø 7 French



1/2

Frazier
18-523-06 19.5cm, 7 1/4" 2.0mm Ø 6 French
18-523-08 19.5cm, 7 1/4" 2.7mm Ø 8 French
18-523-10 19.5cm, 7 1/4" 3.3mm Ø 10 French
18-523-12 19.5cm, 7 1/4" 4.0mm Ø 12 French

Best Seller

Best Seller
Best Seller



1/2

Adson
18-521-21
20cm, 8"
4mm Ø



1/2

Poppen
18-525-06 15cm, 6" 2.0mm Ø 6 French
18-525-08 15cm, 6" 2.7mm Ø 8 French
18-525-10 15cm, 6" 3.3mm Ø 10 French
18-525-12 15cm, 6" 4.0mm Ø 12 French

Suction Tubes, Cannulas
Suction Tubes, Suction Tips

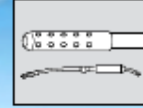

18-543-99
replacement tip, only



Best Seller



Cogswell
23 cm, 9"
00-102-30 size 1 $\varnothing = 1.0$ mm
00-102-31 size 2 $\varnothing = 2.0$ mm
00-102-32 size 3 $\varnothing = 3.0$ mm
00-102-33 size 4 $\varnothing = 4.0$ mm



18-545-10 No. 0 10 cm, 4" $\varnothing = 1.3$ mm	Best Seller	18-545-11 No. 1 10 cm, 4" $\varnothing = 2.3$ mm	18-545-12 No. 2 10 cm, 4" $\varnothing = 3.3$ mm	18-545-13 No. 3 13.5 cm, 5 1/4" with tip $\varnothing = 6$ mm
---	--------------------	---	---	---

Yankauer
18-545-00
31 cm, 12 1/4"
complete with handle,
4 tubes, suction tip
and adaptor

Best Seller



18-545-01
15 cm, 6"
handle

18-545-02
2.5 cm, 1"
adaptor

18

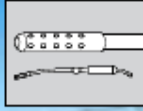

Suction Tubes, Cannulas
Suction Tubes

18



1/2

Andrews - Pynchon
96-256-25
24 cm, 9 1/4"
suction tube



1/2

Nuboer
18-569-21
21 cm, 8 1/4"
6 mm Ø
round opening



1/2

Nuboer
18-571-21
21 cm, 8 1/4"
6 mm Ø
oval opening

Suction Tubes, Cannulas
Suction Tubes, Suction Tips

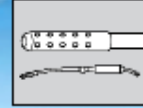

	○ without hole	18-575-01 10 cm, 4" 1.5 mm Ø	
	○	18-575-02 10 cm, 4" 2.0 mm Ø	
	○ Best Seller	18-575-03 10 cm, 4" 2.5 mm Ø	for use with 18-575-24
$\frac{1}{2}$	○ Best Seller	18-575-04 10 cm, 4" 3.5 mm Ø	$\frac{1}{2}$
	○ with hole	18-575-05 10 cm, 4" 1.5 mm Ø	
$\frac{1}{2}$	○	18-575-06 10 cm, 4" 2.0 mm Ø	tip laterally perforated with additional side holes for use with 18-575-24
Coupland 18-575-24 17 cm, 6 1/4" suction handle with tube connector	○	18-575-07 10 cm, 4" 2.5 mm Ø	$\frac{1}{2}$
	○ Best Seller	18-575-08 10 cm, 4" 3.5 mm Ø	

18

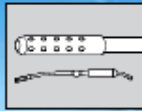

Suction Tubes, Cannulas
Suction Tubes

18



- 18-577-01
1.5 mm Ø
- 18-577-02
2.5 mm Ø
- 18-577-03
3.5 mm Ø

Byrd
18-577-01 – 18-577-03
21.5 cm, 8 1/4"



- 18-579-01
1.6 mm Ø
- 18-579-02 **Best Seller**
2.7 mm Ø
- 18-579-03
4 mm Ø

McKesson
18-579-01 – 18-579-03
18 cm, 6 1/4"



Cogswell
18-579-23
23 cm, 9"
2.0 mm Ø
with finger cut-off

19

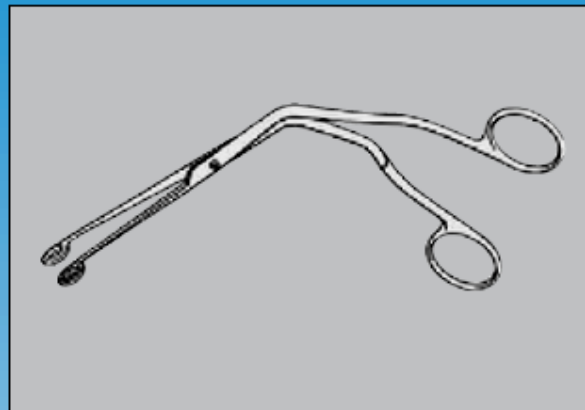

Anesthesia

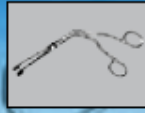

Anesthesia
Catheter Introducing Forceps



M

19-301-15
14.5 cm, 5 7/8"
for babies



19-301-20
20 cm, 8"
for children



19-303-25
25 cm, 10"
for adults

19



1/2

Magill

20

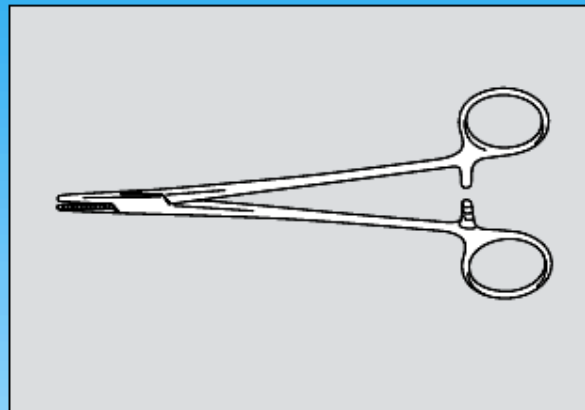

Needle Holders





Needle Holders
Micro Needle Holders



20-010-18
18 cm, 7 1/4"
with lock
diamond-coated jaw
11.0 x 0.8 mm
 7-0 - 12-0



20-020-18
18 cm, 7 1/4"
with lock
diamond-coated jaw
11.0 x 0.8 mm
 7-0 - 12-0
 Titanium



20-048-18
18 cm, 7 1/4"
with lock,
straight



20-049-18
18 cm, 7 1/4"
with lock,
curved



20-050-18
18 cm, 7 1/4"
straight



20-051-18
18 cm, 7 1/4"
curved

20

Needle Holders
Micro Needle Holders

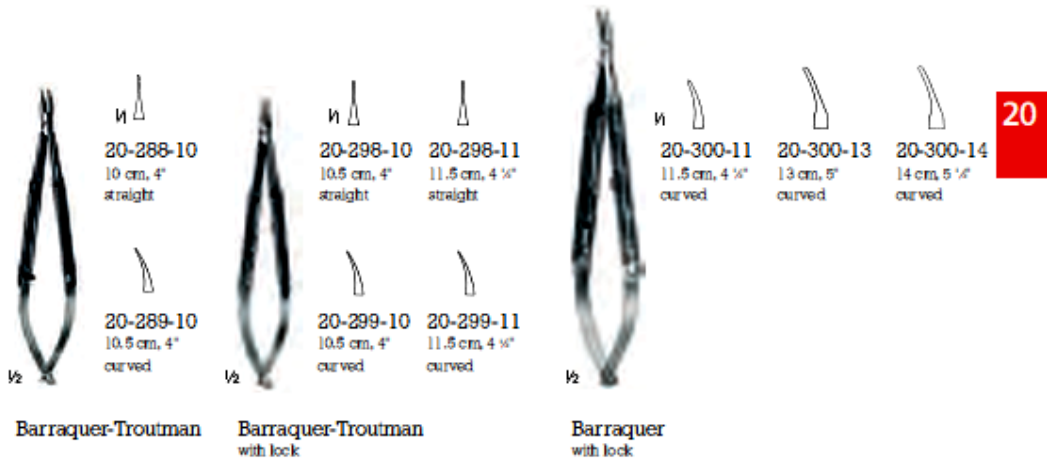
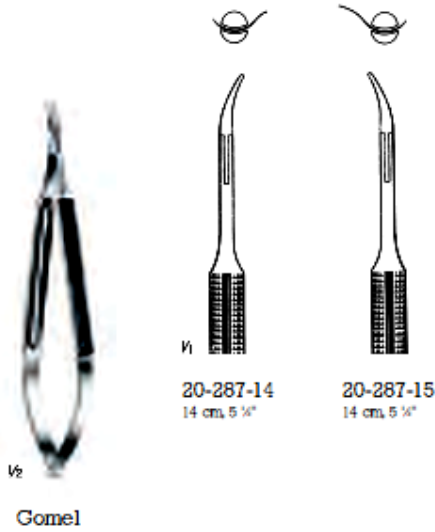



Needle Holders
Micro Needle Holders

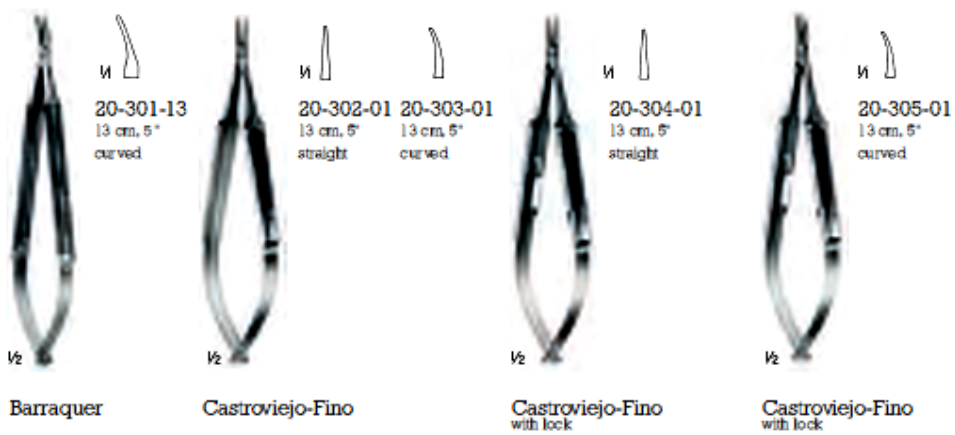

20

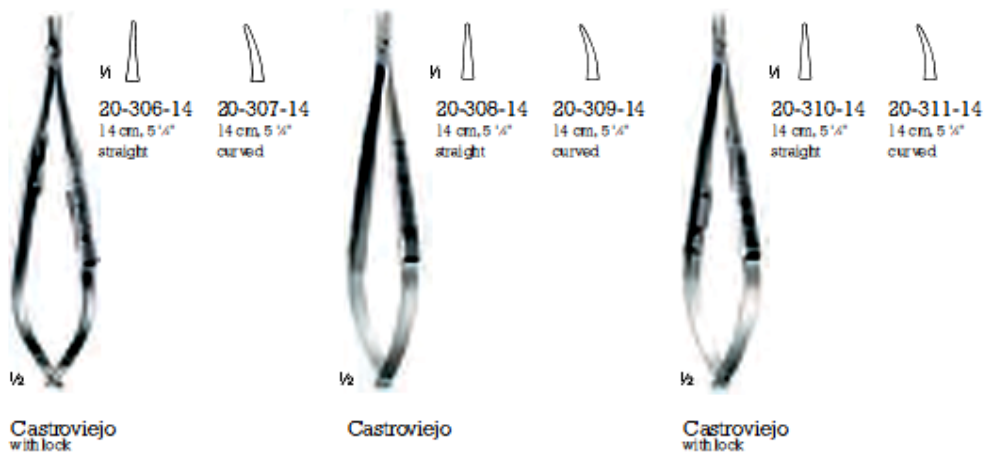

Needle Holders
Micro Needle Holders, Needle Holders

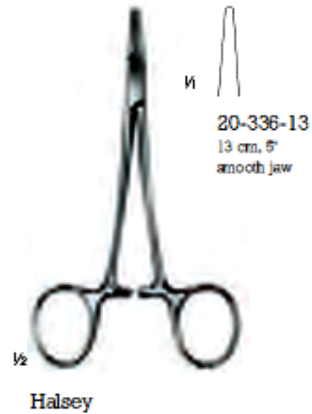
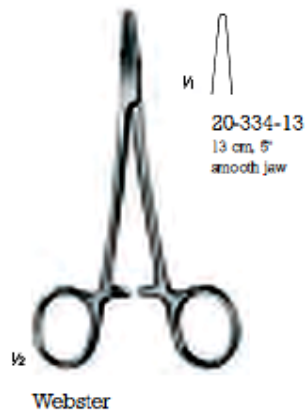
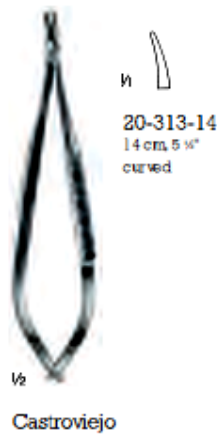

20



Needle Holders
Needle Holders

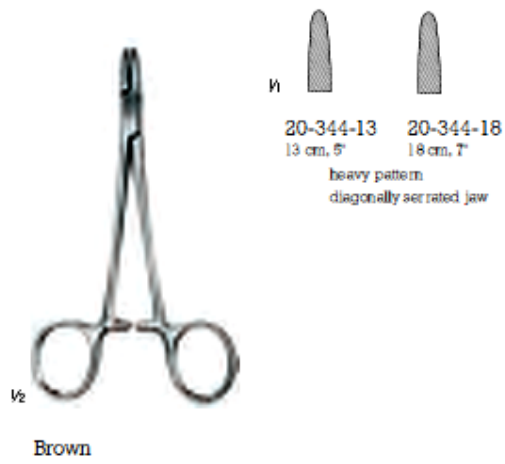

20



Needle Holders
Needle Holders



20-360-18
 18 cm, 7"
 one fenestrated jaw

1/2
 Adson

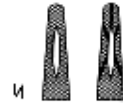

20-364-18
 18.5 cm, 7 1/4"
 one grooved and fenestrated jaw

1/2
 Metzenbaum



- 1/2
- Best Seller**
- 20-390-14
14.5 cm, 5 1/4"
 - 20-390-16
16 cm, 6 1/4"
 - 20-390-18
18.5 cm, 7 1/4"
 - 20-390-20
20.5 cm, 8"
 - 20-390-24
24 cm, 9 1/4"

Mayo-Hegar

20

ELMED 
Serving the Medical Profession Since 1955

PRIMAX 
German Surgical Instruments Since 1955



Needle Holders
Needle Holders

20

1/2



Mayo-Hegar
delicate

И



20-396-16
16 cm, 6 1/4"



20-396-18
18.5 cm, 7 1/4"



20-396-20
20.5 cm, 8"

И



20-403-21
21 cm, 8 1/4"

1/2



Heaney

Needle Holders
Needle Holders – Scissors



These needle holders also have a scissor edge.

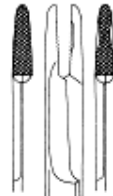

M

20-466-14
14 cm, 5 1/2"



1/2

Olsen-Hegar

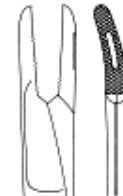

M

20-469-16
16 cm, 6 1/4"



1/2

Gillies



Needle Holders
Micro Needle Holders

20



H



20-589-16
16 cm, 6 1/4"
smooth, curved jaw

1/2



H



20-592-23
23 cm, 9"
smooth, straight jaw

1/2



20-593-23
23 cm, 9"
smooth, curved jaw



20-595-19
19 cm, 7 1/4"
smooth, curved jaw

Needle Holders
Needle Holders



TCGOLD



1/2

Castroviejo



1/2

Par-Style

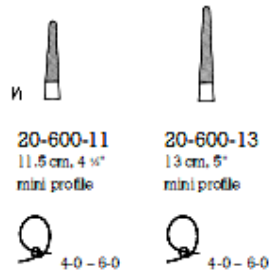

1/2

Crile-Wood

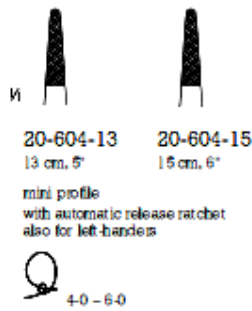

1/2

Jaboma

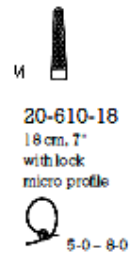



Needle Holders
Micro Needle Holders

TC60LD



20-620-00
14 cm, 5 1/4"
with lock
micro profile
straight

5-0 - 8-0



20-620-01
14 cm, 5 1/4"
with lock
micro profile
curved

5-0 - 8-0



20-620-14
14 cm, 5 1/4"
with lock
smooth jaw
straight

6-0 - 12-0



20-620-18
18 cm, 7"
with lock
micro profile
straight

5-0 - 8-0



20-620-21
21.5 cm, 8 1/2"
with lock
micro profile
straight

5-0 - 8-0

20



1/2
Castroviejo



20-621-14
14 cm, 5 1/4"
with lock
smooth jaw
curved

6-0 - 12-0



20-621-18
18 cm, 7"
with lock
micro profile
curved

5-0 - 8-0



20-621-21
21.5 cm, 8 1/2"
with lock
micro profile
curved

5-0 - 8-0

Needle Holders
Micro Needle Holders, Needle Holders

TCGOLD

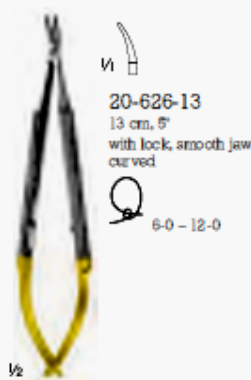

20-626-13
 13 cm, 5"
 with lock, smooth jaw
 curved
 6-0 - 12-0

Barraquer



20-628-13
 13 cm, 5"
 smooth jaw
 curved
 6-0 - 12-0

Barraquer

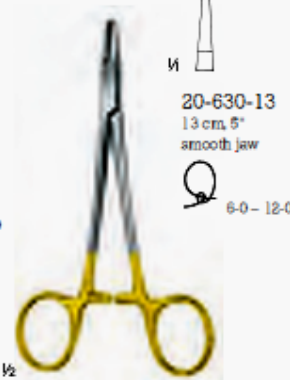

20-630-13
 13 cm, 5"
 smooth jaw
 6-0 - 12-0

Webster



20-630-13-L
 13 cm, 5"
 smooth jaw
 6-0 - 12-0
 left-handed

left-handed



20-631-01
 12 cm, 4 1/4"
 micro profile,
 delicate
 5-0 - 6-0

Micro-Webster

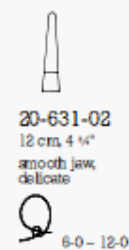

20-631-02
 12 cm, 4 1/4"
 smooth jaw,
 delicate
 6-0 - 12-0

Derf



20-632-12
 12 cm, 4 1/4"
 mini profile
 4-0 - 6-0

Derf



Needle Holders
Needle Holders

TC60LD



Neivert

20-633-13
13.5 cm, 5 1/4"
micro profile
4-0 - 6-0
offset-ring



Hegar-Baumgartner

20-634-13 20-634-13-L 20-634-14
13 cm, 5" 13 cm, 5" 14 cm, 5 1/4"
mini profile mini profile mini profile
4-0 - 6-0 4-0 - 6-0 4-0 - 6-0
left-handed

20



Halsey

20-636-13
13 cm, 5"
smooth jaw
6-0 - 12-0

20-637-13
13 cm, 5"
mini profile
4-0 - 6-0

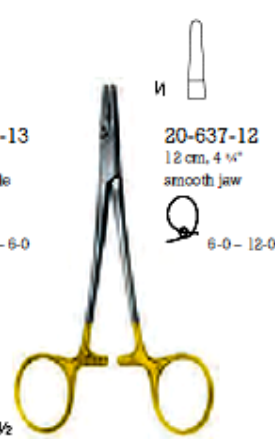

Webster

20-637-12
12 cm, 4 1/4"
smooth jaw
6-0 - 12-0



Baby Crile-Wood

96-200-68
15 cm, 6"
mini profile
4-0 - 6-0

Needle Holders
Needle Holders



TCGOLD

Best Seller



20-638-15
15 cm, 6"
mini profile
4-0 - 6-0

Crile-Wood



20-638-15-L
15 cm, 6"
mini profile
4-0 - 6-0

left-handed

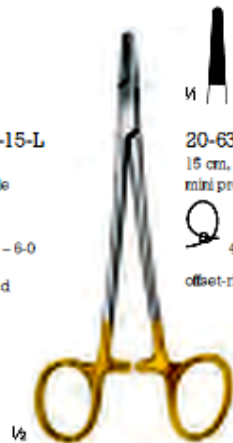

20-639-15
15 cm, 6"
mini profile
4-0 - 6-0

1/2

Crile-Wood



20-640-18
18 cm, 7"
standard profile
4-0 - 6-0

1/2

Sarot



20-640-20
20 cm, 8"
standard profile
4-0 - 6-0

Best Seller



20-642-16
16 cm, 6 1/4"
left-handed
4-0 - 6-0

1/2

Mayo-Hegar



20-642-16-L
16 cm, 6 1/4"
left-handed
4-0 - 6-0

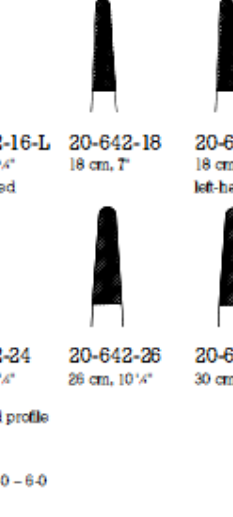

20-642-18
18 cm, 7"
left-handed
4-0 - 6-0

1/2

Best Seller



20-642-24
24 cm, 9 1/2"
standard profile
4-0 - 6-0

1/2

Mayo-Hegar

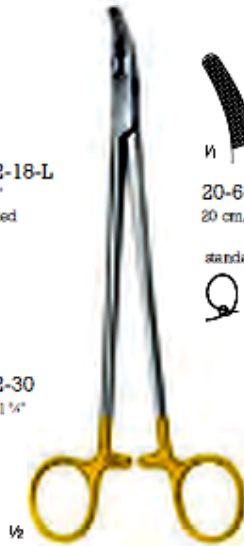

20-643-20
20 cm, 8"
standard profile
4-0 - 6-0

1/2

Heaney

20

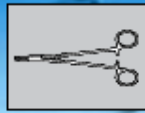







Needle Holders
Needle Holders

TCGOLD



DeBakey





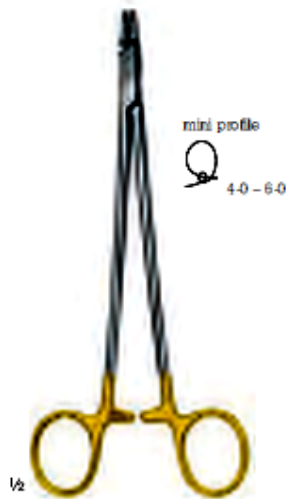

Best Seller

- | | | |
|---|---|--|
|  |  |  |
| 20-646-18
18 cm, 7" | 20-646-18-L
18 cm, 7"
left-handed | 20-646-20
20 cm, 8" |
|  |  |  |
| 20-646-23
23 cm, 9" | 20-646-26
26.5 cm, 10 1/4" | 20-646-31
31 cm, 12 1/4" |

20



Ryder (Martin)

- | | | |
|---|---|--|
|  |  |  |
| 20-650-13
13 cm, 5" | 20-650-15
15 cm, 6" | 20-650-18
18 cm, 7" |
|  |  |  |
| 20-650-20
20 cm, 8" | 20-650-23
23 cm, 9" | 20-650-26
26 cm, 10 1/4" |



TCGOLD



1/2
Martin

slender pattern
mini profile
40-60







- | | | |
|---|---|---|
|  |  |  |
| 20-652-15
15 cm, 6" | 20-652-17
17 cm, 6 1/4" | 20-652-20
20 cm, 8" |



1/2

Ryzier-Vascular

slender pattern
micro profile
50-80





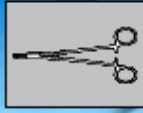





- | | | |
|---|---|---|
|  |  |  |
| 20-654-13
12.5 cm, 5" | 20-654-15
15.5 cm, 6" | 20-654-18
17.5 cm, 7" |
|  |  |  |
| 20-654-20
20 cm, 8" | 20-654-23
22.5 cm, 8 3/4" | 20-654-26
26 cm, 10 1/4" |

20















Needle Holders
Needle Holders

TCGOLD

 1/2 Hegar-Vascular	slender pattern micro profile  5-0 - 8-0	 20-658-14 14 cm, 5 1/4"	 20-658-18 18.5 cm, 7 1/4"	 1/2 Microvascular	slender pattern micro profile  5-0 - 8-0	 20-666-00 14.5 cm, 5 1/4"	 20-666-02 18 cm, 7"
		 20-658-20 20.5 cm, 8"	 20-658-23 23 cm, 9"			 20-666-03 20 cm, 8"	 20-666-04 23 cm, 9"

20

 1/2 Martini	slender pattern smooth jaw  6-0 - 12-0	 20-668-00 14 cm, 5 1/4"	 20-668-01 16 cm, 6 1/4"	 1/2 Martini	slender pattern micro profile  5-0 - 8-0	 20-670-00 14 cm, 5 1/4"	 20-670-01 16 cm, 6 1/4"
		 20-668-02 18 cm, 7"	 20-668-03 20 cm, 8"			 20-670-02 18 cm, 7"	 20-670-03 20 cm, 8"



TCGOLD

These needle holders also have a scissor edge.

smooth 20-671-14 20-671-17
14 cm, 5 1/4" 17 cm, 6 1/4"

4-0 - 6-0

1/2
Olsen-Hegar

standard profile 20-672-11 20-672-14
11.5 cm, 4 1/2" 14 cm, 5 1/4"

4-0 - 6-0

20-672-17 20-672-18
17 cm, 6 1/4" 18 cm, 7"

1/2
Olsen-Hegar

These needle holders also have a scissor edge.

20-673-15
15 cm, 6"
mini profile

4-0 - 6-0

1/2
Foster-Gillies

20-673-16
16 cm, 6 1/4"
standard profile

4-0 - 6-0

1/2
Gillies

01-005-79
15 cm, 6"
mini profile

4-0 - 6-0

1/2
Crile-Wood

20

21

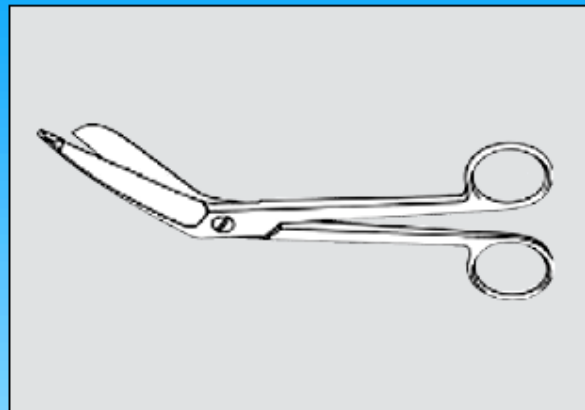

Bandage and Plaster Scissors



Bandage and Plaster Scissors



Lister



21-165-14 = 14 cm, 5 1/2"
21-165-18 = 18 cm, 7"
21-165-20 = 20 cm, 8"



Lister



21-209-15 = 15 cm, 6"
21-209-18 = 18 cm, 7"
black plastic rings
not occlusable
up to 280 °F

21



Bergmann

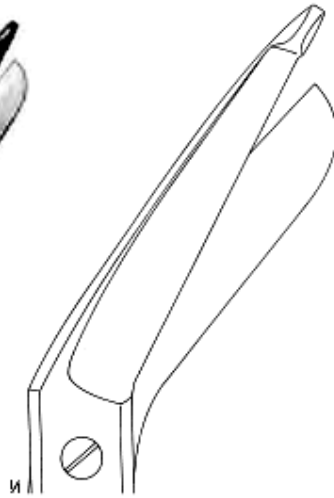

21-195-23
23 cm, 9"
heavy pattern



Esmarch

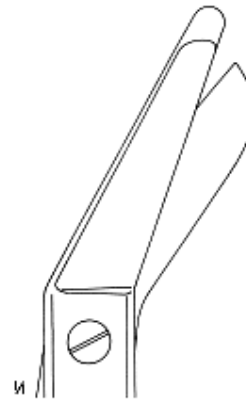

21-205-20
20 cm, 8"
heavy pattern, short blades

22

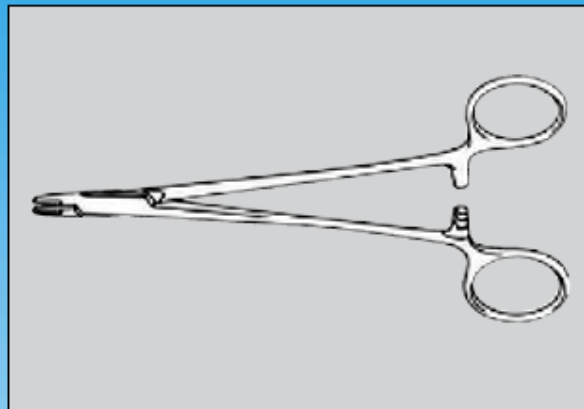

Wire Instruments

ELMED 
Serving the Medical Profession Since 1955

PRIMAX 
German Surgical Instruments Since 1955



Wire Instruments
Wire Twisting Forceps



22-480-15
15.5 cm, 6"



22-482-15
15.5 cm, 6"

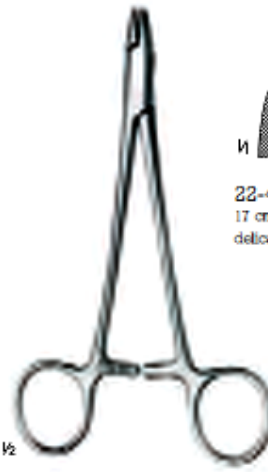

22-486-17
17 cm, 6 1/4"
delicate

Levine

22



22-489-15
15 cm, 6"

TCGOLD



22-492-14
14 cm, 5 1/2"

TCGOLD



22-498-14
14 cm, 5 1/2"

Wire Instruments
Wire Twisting Forceps



TCGOLD

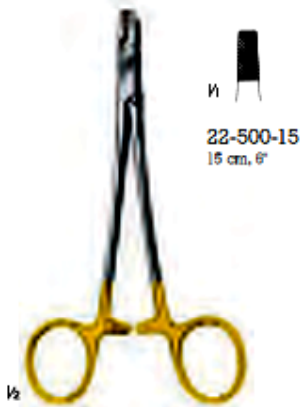
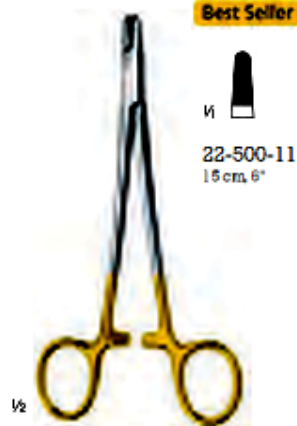

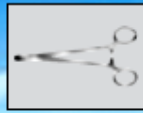

Wire Instruments
Wire Twisting Forceps

TC60LD

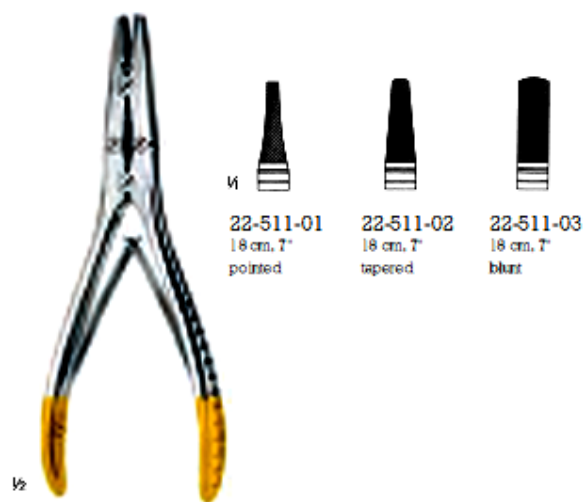

22

Marin
wire cutting, twisting forceps

flat nose pliers

Wire Instruments
Wire Cutting Pliers



1/2

Kirschner
 22-522-16
 16 cm, 6 1/4"
 wire cutter, front action

for soft wires up to
 2.2 mm Ø
 for hard wires up to
 2.0 mm Ø

TCGOLD



1/2

22-526-18
 18 cm, 7"
 wire cutting plier



for soft wires up to
 2.0 mm Ø
 for hard wires up to
 1.5 mm Ø